

# Relative Quantification Getting Started Guide

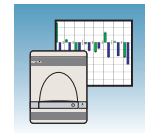

Introduction and  
Example  
RQ Experiment

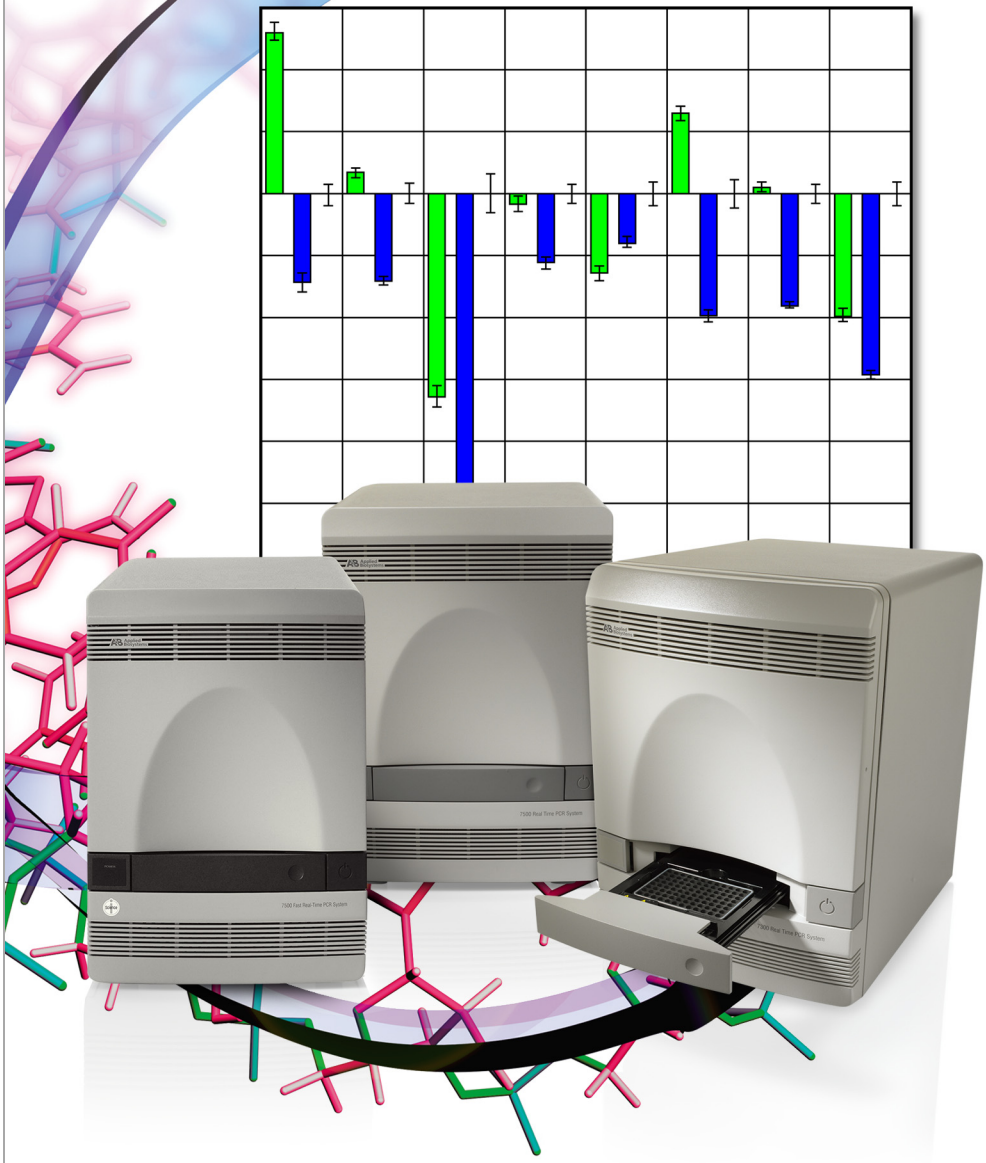
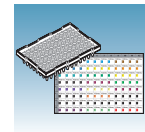

Designing an  
RQ Experiment

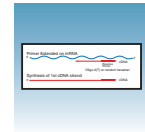

Performing  
Reverse  
Transcription

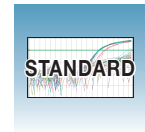

Generating Data  
from RQ Plates –  
7300 or Standard  
7500 System



Generating Data  
from RQ Plates –  
7500 Fast System

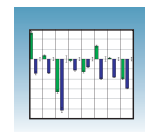

Analyzing Data in  
an RQ Study

© Copyright 2006, 2010 Applied Biosystems. All rights reserved.

**For Research Use Only. Not for use in diagnostic procedures.**

**NOTICE TO PURCHASER:**

The Applied Biosystems 7300, 7500 and 7500 Fast Real-Time PCR Systems are real-time thermal cyclers covered by US patents and corresponding claims in their non-US counterparts, owned by Applied Biosystems. No right is conveyed expressly, by implication or by estoppel under any other patent claim, such as claims to apparatus, reagents, kits, or methods such as 5' nuclease methods. Further information on purchasing licenses may be obtained by contacting the Director of Licensing, Applied Biosystems, 850 Lincoln Centre Drive, Foster City, California 94404, USA.

**Trademarks**

Applera, Applied Biosystems, AB (Design), ABI PRISM, MicroAmp, Primer Express, and VIC are registered trademarks and FAM, MultiScribe, ROX, and TAMRA are trademarks of Applied Biosystems or its subsidiaries in the US and/or certain other countries.

AmpErase, AmpliTaq Gold, and TaqMan are registered trademarks of Roche Molecular Systems, Inc.

SYBR is a registered trademark of Molecular Probes, Inc.

Microsoft and Windows are registered trademarks of Microsoft Corporation.

All other trademarks are the sole property of their respective owners.

Part Number 4378655 Rev. B  
06/2010

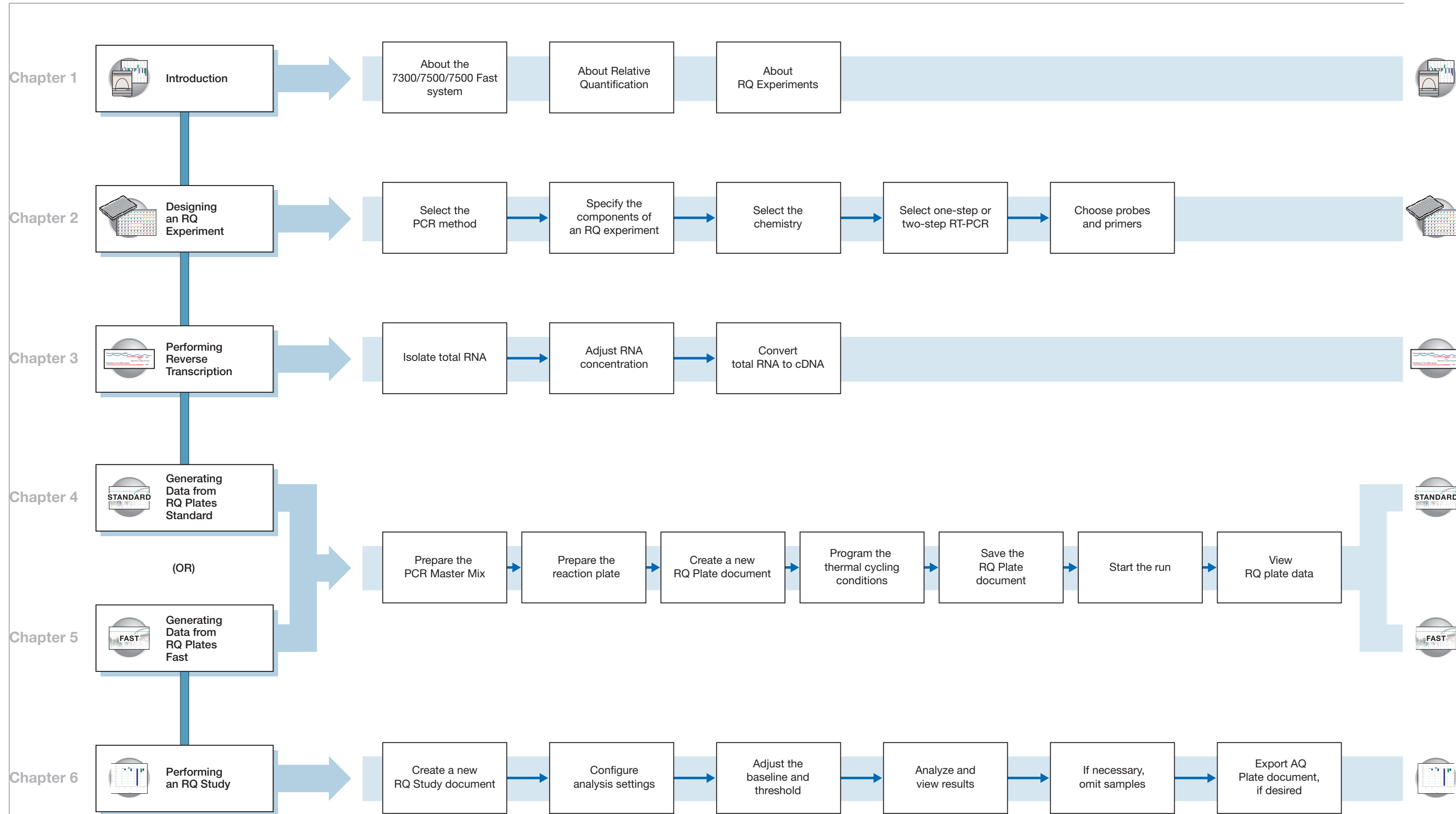



# Contents

	<b>Relative Quantification Experiment Workflow</b>	<b>iii</b>
	<b>Preface</b>	<b>vii</b>
	How to Use This Guide	vii
	How to Obtain More Information	ix
	How to Obtain Support	x
<b>Chapter 1</b>	<b>Introduction</b>	<b>1</b>
	About the 7300/7500/7500 Fast System	2
	About Relative Quantification	2
	About RQ Experiments	3
<b>Chapter 2</b>	<b>Designing an RQ Experiment</b>	<b>7</b>
	Selecting the PCR Method	8
	Specifying the Components of an RQ Experiment	9
	Selecting the Chemistry	11
	Selecting One- or Two-Step RT-PCR	12
	Choosing the Probes and Primers	14
<b>Chapter 3</b>	<b>Performing Reverse Transcription</b>	<b>17</b>
	Guidelines for Preparing RNA	18
	Converting Total RNA to cDNA	19
<b>Chapter 4</b>	<b>Generating Data from RQ Plates – 7300 or Standard 7500 System</b>	<b>21</b>
	Before You Begin	22
	Preparing the PCR Master Mix	22
	Preparing the Reaction Plate	23
	Creating a Relative Quantification (RQ) Plate Document	25
	Specifying Thermal Cycling Conditions and Starting the Run	30
	Analyzing and Viewing RQ Plate Data	33
	Exporting RQ Plate Data	36

<b>Chapter 5</b>	<b>Generating Data from RQ Plates – 7500 Fast System</b>	<b>37</b>
	Before You Begin .....	38
	Preparing the PCR Master Mix .....	38
	Preparing the Reaction Plate .....	40
	Creating a Relative Quantification (RQ) Plate Document .....	43
	Specifying Thermal Cycling Conditions and Starting the Run .....	48
	Analyzing and Viewing RQ Plate Data .....	52
	Exporting RQ Plate Data .....	55
	Troubleshooting .....	56
<b>Chapter 6</b>	<b>Analyzing Data in an RQ Study</b>	<b>59</b>
	Creating an RQ Study Document .....	60
	Configuring Analysis Settings .....	63
	Adjusting the Baseline and Threshold .....	65
	Analyzing and Viewing the Results of the RQ Study .....	70
	Reanalyzing an RQ Study .....	74
	Omitting Samples from a Study .....	75
	Exporting RQ Study Data .....	78
<b>Appendix A</b>	<b>Creating Detectors</b>	<b>79</b>
<b>Appendix B</b>	<b>Example RQ Experiment</b>	<b>81</b>
	<b>References</b>	<b>89</b>
	<b>Index</b>	<b>91</b>

## How to Use This Guide

**Purpose of This Guide** This guide is written for principal investigators and laboratory staff who conduct relative quantification studies for gene expression using the Applied Biosystems 7300/7500/7500 Fast Real-Time PCR System.

**Assumptions** This guide assumes that you have:

- Familiarity with Microsoft® Windows® XP operating system.
- Knowledge of general techniques for handling DNA and RNA samples and preparing them for PCR.
- A general understanding of hard drives and data storage, file transfers, and copying and pasting.
- Networking experience, if you want to integrate the 7300/7500/7500 Fast system into your existing laboratory data flow system.

**Text Conventions** This guide uses the following conventions:

- **Bold** indicates user action. For example:  
Type **0**, then press **Enter** for each of the remaining fields.
- *Italic* text indicates new or important words and is also used for emphasis. For example:  
Before analyzing, *always* prepare fresh matrix.
- A right arrow bracket (>) separates successive commands you select from a drop-down or shortcut menu. For example:  
Select **File > Open > Spot Set**.

**User Attention Words** The following user attention words appear in Applied Biosystems user documentation. Each word implies a particular level of observation or action as described below:

**Note** – Provides information that may be of interest or help but is not critical to the use of the product.

**IMPORTANT!** – Provides information that is necessary for proper instrument operation, accurate chemistry kit use, or safe use of a chemical.



**CAUTION** Indicates a potentially hazardous situation that, if not avoided, may result in minor or moderate injury. It may also be used to alert against unsafe practices.



**WARNING** Indicates a potentially hazardous situation that, if not avoided, could result in death or serious injury.

**Safety** Chemical manufacturers supply current Material Safety Data Sheets (MSDSs) with shipments of hazardous chemicals to *new* customers. They also provide MSDSs with the first shipment of a hazardous chemical to a customer after an MSDS has been updated. MSDSs provide the safety information you need to store, handle, transport, and dispose of the chemicals safely.

Each time you receive a new MSDS packaged with a hazardous chemical, be sure to replace the appropriate MSDS in your files.

You can obtain from Applied Biosystems the MSDS for any chemical supplied by Applied Biosystems. This service is free and available 24 hours a day.

To obtain MSDSs:

1. Go to <https://docs.appliedbiosystems.com/msdssearch.html>
2. In the Search field, type in the chemical name, part number, or other information that appears in the MSDS of interest. Select the language of your choice, then click **Search**.
3. Find the document of interest, right-click the document title, then select any of the following:
  - **Open** – To view the document
  - **Print Target** – To print the document
  - **Save Target As** – To download a PDF version of the document to a destination that you choose
4. To have a copy of a document sent by fax or e-mail, select **Fax** or **Email** to the left of the document title in the Search Results page, then click **RETRIEVE DOCUMENTS** at the end of the document list.

After you enter the required information, click **View/Deliver Selected Documents Now**.

Refer to the *Applied Biosystems 7300/7500/7500 Fast Real-Time PCR System Installation and Maintenance Getting Started Guide* and the *Applied Biosystems 7300/7500/7500 Fast Real-Time PCR System Site Preparation Guide* for important safety information.



## How to Obtain More Information

**Related Documentation** For more information about using the 7300/7500/7500 Fast system, refer to the *Applied Biosystems 7300/7500/7500 Fast Real-Time PCR System Online Help* or the documents shown below.

Document Title	Online Help P/N	P/N
<i>Applied Biosystems 7300/7500/7500 Fast Real-Time PCR System Plus/Minus Detection Getting Started Guide</i>	4347821	4378652
<i>Applied Biosystems 7300/7500/7500 Fast Real-Time PCR System Allelic Discrimination Getting Started Guide</i>	4347822	4378653
<i>Applied Biosystems 7300/7500/7500 Fast Real-Time PCR System Absolute Quantification Getting Started Guide</i>	4347825	4378656
<i>Applied Biosystems 7300/7500/7500 Fast Real-Time PCR System Site Preparation Guide</i>	4347823	4378654
<i>Applied Biosystems 7300/7500/7500 Fast Real-Time PCR System Installation and Maintenance Guide</i>	4347828	4378657
<i>Real-Time PCR Systems Chemistry Guide</i>	4348358	4378658
<i>Applied Biosystems 7500 FAST Real-Time PCR System, QRC</i>	4362285	4378659
<i>Applied Biosystems Real-Time System Computer Set Up Guide, QRC</i>	4365367	4378660
<i>ABI PRISM® 7700 Sequence Detection System User Bulletin #2: Relative Quantitation of Gene Expression</i>	4303859	

**Send Us Your Comments** Applied Biosystems welcomes your comments and suggestions for improving its user documents. You can e-mail your comments to:

[techpubs@appliedbiosystems.com](mailto:techpubs@appliedbiosystems.com)

## How to Obtain Support

To contact Applied Biosystems Technical Support from North America by telephone, call **1.800.899.5858**.

For the latest services and support information for all locations, go to <http://www.appliedbiosystems.com>, then click the link for **Support**.

At the Support page, you can:

- Obtain worldwide telephone and fax numbers to contact Applied Biosystems Technical Support and Sales facilities
- Search through frequently asked questions (FAQs)
- Submit a question directly to Technical Support
- Order Applied Biosystems user documents, MSDSs, certificates of analysis, and other related documents
- Download PDF documents
- Obtain information about customer training
- Download software updates and patches

# Introduction

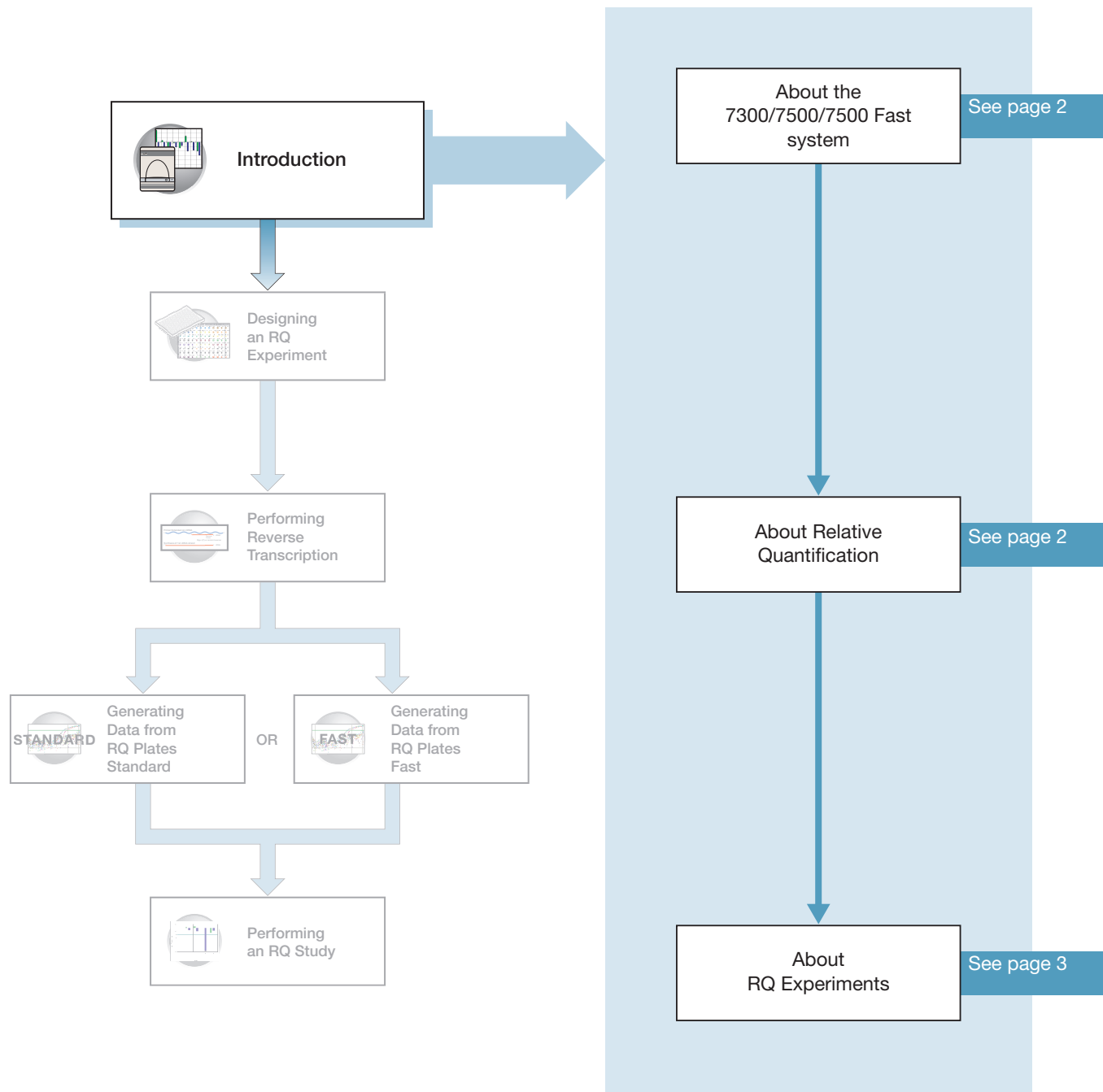
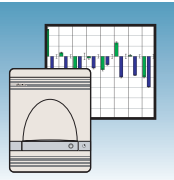

Notes

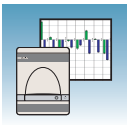

## About the 7300/7500/7500 Fast System

**Description** The Applied Biosystems 7300/7500/7500 Fast Real-Time PCR System uses fluorescent-based PCR chemistries to provide quantitative detection of nucleic acid sequences using real-time analysis and qualitative detection of nucleic acid sequences using end-point and dissociation-curve analysis. The Applied Biosystems 7500 Fast Real-Time PCR System allows the user to perform high speed thermal cycling giving run times for quantitative real-time PCR applications (such as relative quantification) in fewer than 40 minutes.

**Relative Quantification Assay** The 7300/7500/7500 Fast system allows the user to perform several assay types using plates or tubes in the 96-well format. This guide describes the relative quantification (RQ) assay type.

For information about the other assay types, refer to the *Real-Time PCR Systems Chemistry Guide* (PN 4378658) and the Online Help for the 7300/7500/7500 Fast system (Online Help).

## About Relative Quantification

**Real-time PCR Assays** RQ is performed using real-time PCR. In real-time PCR assays, you monitor the progress of the PCR as it occurs. Data are collected throughout the PCR process rather than at the end of the PCR process (end-point PCR).

In real-time PCR, reactions are characterized by the point in time during cycling when amplification of a target is first detected rather than by the amount of target accumulated at the end of PCR.

There are two types of quantitative real-time PCR: absolute and relative.

**Definition** Relative quantification determines the change in expression of a nucleic acid sequence (target) in a test sample relative to the same sequence in a calibrator sample. The calibrator sample can be an untreated control or a sample at time zero in a time-course study (Livak and Schmittgen, 2001). For example, relative quantification is commonly used to compare expression levels of wild-type with mutated alleles or the expression levels of a gene in different tissues.

RQ provides accurate comparison between the initial level of template in each sample, without requiring the exact copy number of the template. Further, the relative levels of templates in samples can be determined without the use of standard curves.

Notes \_\_\_\_\_

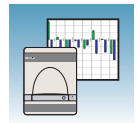

## About RQ Experiments

### RQ Experiment Workflow

In this document, the term “RQ experiment” refers to the entire process of relative quantification, beginning with generating cDNA from RNA (reverse transcription) and ending with analyzing an RQ study. The RQ experiment workflow is shown on [page iii](#).

### RQ Studies with the 7300/7500/7500 Fast System

The data-collection part of an RQ assay is a single-plate document, called the RQ Plate. Amplification data from PCR runs is stored with sample setup information on the plate.

The data-analysis part of an RQ assay is a multi-plate document, called the RQ Study. You can analyze up to ten RQ plates in a study. RQ Study documents neither control the instrument, nor do they provide tools for setting up or modifying plates.

---

**IMPORTANT!** RQ Study software is an optional package for the 7300 instrument but it is standard for the 7500 instrument and the 7500 Fast instrument.

---

The following figure illustrates the RQ Study process.

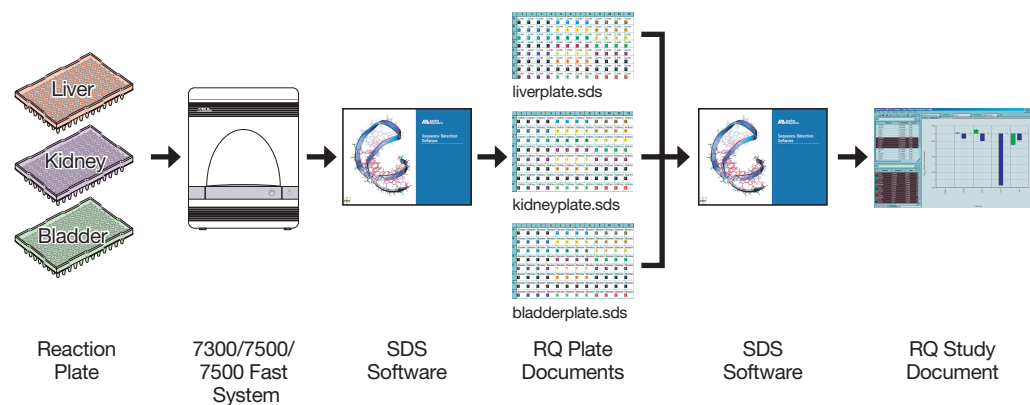



---

**Note:** The 7300/7500/7500 Fast system software uses the comparative method ( $\Delta\Delta C_T$ ) to calculate relative quantities of a nucleic acid sequence. If you want to perform relative quantification using the relative standard curve method, you should use an AQ assay type and consult the *Real-Time PCR Systems Chemistry Guide* for details on how to set up a run and analyze this type of assay.

---

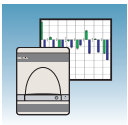
### Notes



## Terms Used in Quantification Analysis

Term	Definition
Baseline	The initial cycles of PCR in which there is little change in fluorescence signal.
Threshold	A level of $\Delta R_n$ —automatically determined by the SDS Software 1.3.1 or manually set—used for $C_T$ determination in real-time assays. The level is set to be above the baseline and sufficiently low to be within the exponential growth region of the amplification curve. The threshold is the line whose intersection with the Amplification plot defines the $C_T$ .
Threshold cycle ( $C_T$ )	The fractional cycle number at which the fluorescence passes the threshold.
Passive reference	A dye that provides an internal fluorescence reference to which the reporter dye signal can be normalized during data analysis. Normalization is necessary to correct for fluorescence fluctuations caused by changes in concentration or in volume.
Reporter dye	The dye attached to the 5' end of a TaqMan <sup>®</sup> probe. The dye provides a signal that is an indicator of specific amplification.
Normalized reporter ( $R_n$ )	The ratio of the fluorescence emission intensity of the reporter dye to the fluorescence emission intensity of the passive reference dye.
Delta $R_n$ ( $\Delta R_n$ )	The magnitude of the signal generated by the specified set of PCR conditions ( $\Delta R_n = R_n - \text{baseline}$ ).

The figure below shows a representative amplification plot and includes some of the terms defined in the previous table.

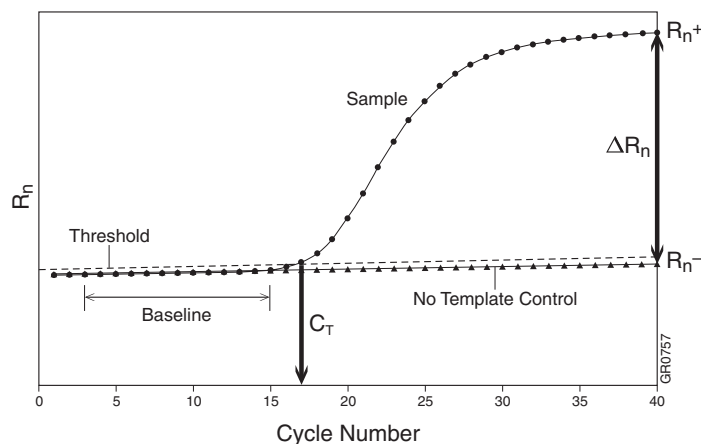

Notes \_\_\_\_\_

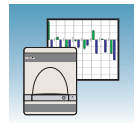

**Required  
User-Supplied  
Materials**

Item	Source
ABI PRISM® 6100 Nucleic Acid PrepStation	Applied Biosystems - (PN 6100-01)
High Capacity cDNA Archive Kit	Applied Biosystems - (PN 4322171)
TaqMan® Universal PCR Master Mix	Applied Biosystems- (PN 4304437)
TaqMan® Fast Universal PCR Master Mix (2X) No AmpErase® UNG	Applied Biosystems - (PN 4352042)
MicroAmp® Optical 96-Well Reaction Plate	Applied Biosystems - (PN 4306757)
Optical 96-Well Fast Thermal Cycling Plate with Barcode (code 128)	Applied Biosystems - (PN 4346906)
Optical Adhesive Cover	Applied Biosystems- (PN 4311971)
Labeled primers and probes from one of the following sources: <ul style="list-style-type: none"> <li>• TaqMan® Gene Expression Assays (pre-designed primers and probes)</li> <li>• TaqMan® Custom Gene Expression Assays service (pre-designed primers and probes)</li> <li>• Primer Express® Software (custom-designed primers and probes)</li> </ul>	<ul style="list-style-type: none"> <li>• Applied Biosystems Web site</li> <li>• Contact your Applied Biosystems Sales Representative</li> </ul>
Reagent tubes with caps, 10-mL	Applied Biosystems (PN 4305932)
Centrifuge with adapter for 96-well plates	Major laboratory supplier (MLS)
Gloves	MLS
Microcentrifuge	MLS
Microcentrifuge tubes, sterile 1.5-mL	MLS
Nuclease-free water	MLS
Pipette tips, with filter plugs	MLS
Pipettors, positive-displacement	MLS
Safety goggles	MLS
Vortexer	MLS

## Example RQ Experiment

To better illustrate how to design, perform, and analyze RQ experiments, this section guides you through an example experiment. The example experiment represents a typical RQ experiment setup that you can use as a quick-start procedure to familiarize yourself with the RQ workflow. Detailed steps in the RQ workflow are described in the

Notes \_\_\_\_\_

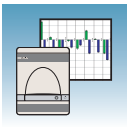

## Chapter 1 Introduction

*About RQ Experiments*

subsequent chapters of this guide. Also in the subsequent chapters are Example Experiment boxes that provide details for some of the related steps in the example experiment. Refer to [Appendix B, “Example RQ Experiment,”](#) on [page 81](#) for more information.

Notes \_\_\_\_\_

\_\_\_\_\_

\_\_\_\_\_



# Designing an RQ Experiment

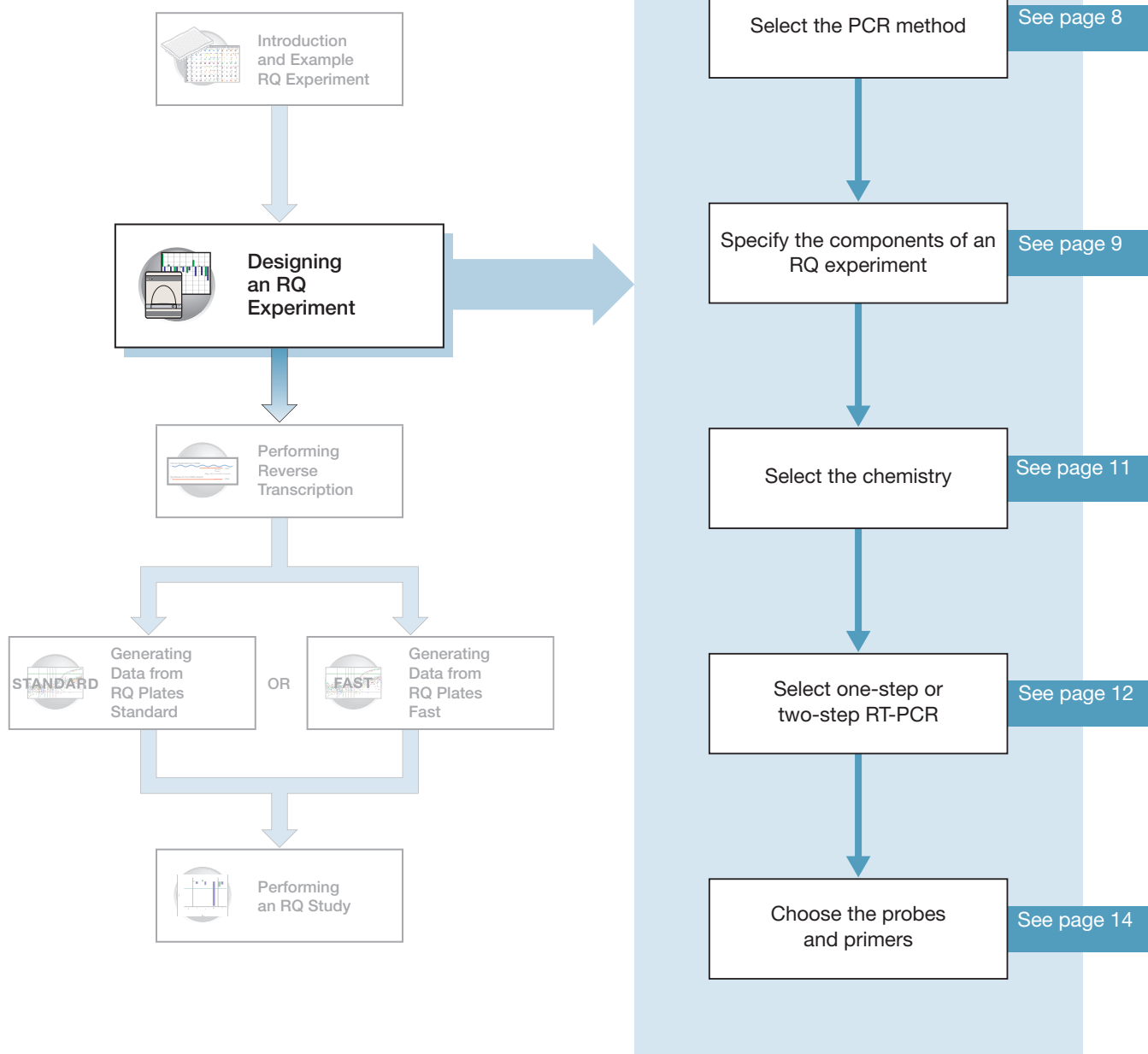
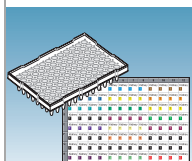

2

Notes

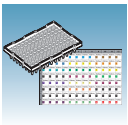

## Selecting the PCR Method

### Types of PCR Methods

PCR is performed as either of the following:

- A singleplex reaction, where a single primer pair is present in the reaction tube or well. Only one target sequence or endogenous control can be amplified per reaction.
- A multiplex reaction, where two or more primer pairs are present in the reaction. Each primer pair amplifies either a target sequence or an endogenous control.

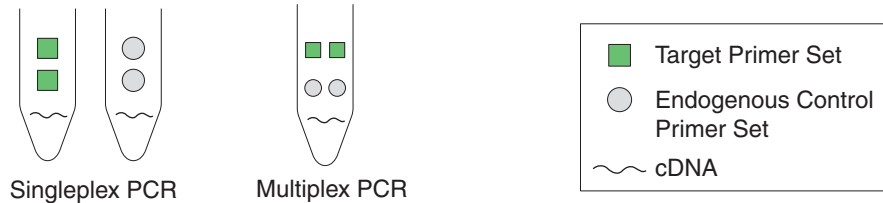

### Selection Criteria

Both methods give equivalent results for relative quantification experiments. To select a method, consider the:

- Type of chemistry you use to detect PCR products – Singleplex PCR can use either SYBR<sup>®</sup> Green or TaqMan<sup>®</sup> reagent-based chemistry. Multiplex PCR can use only TaqMan reagent-based chemistry.
- Amount of time you want to spend optimizing and validating your experiment – Amplifying target sequences and endogenous controls in separate reactions (singleplex PCR) requires less optimization and validation than multiplex PCR. Among the factors to consider in multiplex PCR are primer limitation, the relative abundance of the target and reference sequences (the endogenous control must be more abundant than the targets), and the number of targets in the study.

**IMPORTANT!** As the number of gene targets increases, the singleplex format is typically more effective than the multiplex format because less optimization is required.

Additionally, running multiple reactions in the same tube increases throughput and reduces the effects of pipetting errors.

For more information about multiplex and singleplex PCR, refer to the *Real-Time PCR Systems Chemistry Guide* (PN 4343978).

### Sample Experiment

The singleplex PCR method is used in the example experiment because:

- The number of targets to be amplified (23 genes, plus one endogenous control) is large
- Optimization and validation requirements are reduced for singleplex experiments

Notes \_\_\_\_\_

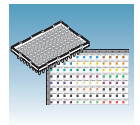

## Specifying the Components of an RQ Experiment

After you decide to use the singleplex or multiplex method, specify the required components of the RQ experiment for every sample:

- **A target** – The nucleic acid sequence that you are studying.
- **A calibrator** – The sample used as the basis for comparative results.
- **An endogenous control** – A gene present at a consistent expression level in all experimental samples. By using an endogenous control as an active reference, you can normalize quantification of a cDNA target for differences in the amount of cDNA added to each reaction. Note that:
  - Each sample type (for example, each tissue in a study comparing multiple tissues) requires an endogenous control.
  - If samples are spread across multiple plates, each plate must have an endogenous control. Additionally, every plate must include an endogenous control for every sample type on the plate.

Typically, housekeeping genes such as  $\beta$ -actin, glyceraldehyde-3-phosphate (GAPDH), and ribosomal RNA (rRNA) are used as endogenous controls, because their expression levels tend to be relatively stable.

- **Replicate wells** – For relative quantification studies, Applied Biosystems recommends the use of three or more replicate reactions per sample and endogenous control to ensure statistical significance.

For more information about these requirements, refer to the *Real-Time PCR Systems Chemistry Guide*.

Notes \_\_\_\_\_

\_\_\_\_\_

\_\_\_\_\_

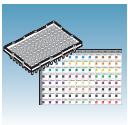

**Sample Experiment**

In the example experiment, the objective is to compare the expression levels of several genes in the liver, kidney, and bladder tissue of an individual. The 23 genes of interest, including ACVR1, ACVR2, CCR2, CD3D, and FLT4, are the targets and the liver samples serve as the calibrator.

The SDS Software 1.3.1 sets gene expression levels for the calibrator samples to 1. Consequently, if more ACVR1 is in the kidney than in the liver, the gene expression level of ACVR1 in the kidney is greater than 1. Similarly, if less CD3D is in the bladder than in the liver, the gene expression level of CD3D in the bladder is less than 1.

Because RQ is based on PCR, the more template in a reaction, the more the PCR product and the greater the fluorescence. To adjust for possible differences in the amount of template added to the reaction, GAPDH serves as an endogenous control. (Expression levels of the endogenous control are subtracted from expression levels of target genes.) An endogenous control is prepared for each tissue.

The experiment includes three sets of endogenous controls—one for each tissue. Also, the endogenous control for each tissue must be amplified on the same plate as the target sequences for that tissue. Finally, note that the experiment uses the singleplex PCR format, and therefore, the endogenous controls are amplified in wells different from the target wells.

Four replicates of each sample and endogenous control are performed to ensure statistical significance (see below).

**Note:** The example RQ experiment requires a separate plate for each of the three tissues because of the large number of genes being studied. You can also design experiments so that several samples are amplified on the same plate, as shown in the following table.

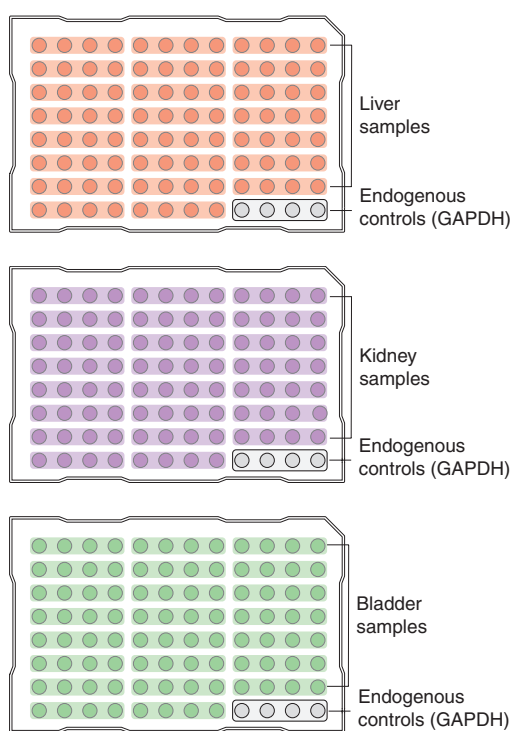
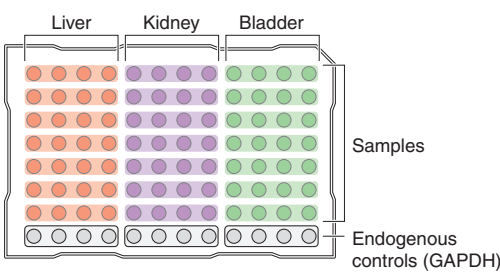
Singleplex Assay	Multiplex Assay
<p>In the example RQ experiment, each plate contains a single sample type (tissue). The endogenous control for each tissue is on the same plate as the targets for that tissue.</p>  <p>Liver samples Endogenous controls (GAPDH)</p> <p>Kidney samples Endogenous controls (GAPDH)</p> <p>Bladder samples Endogenous controls (GAPDH)</p>	<p>If the example experiment were run with multiple sample types on the same plate, an endogenous control for each sample type must also be included on the same plate, as shown here.</p>  <p>Liver    Kidney    Bladder</p> <p>Samples</p> <p>Endogenous controls (GAPDH)</p>

Notes \_\_\_\_\_

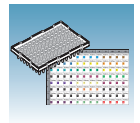

# Selecting the Chemistry

**About Chemistries** Applied Biosystems offers two types of chemistries that you can use to detect PCR products on real-time instruments, as explained in the following table. Both TaqMan® probe-based and SYBR® Green I dye chemistries can be used for either one- or two-step RT-PCR. For more information about these chemistries, refer to the *Real-Time PCR Systems Chemistry Guide*.

Chemistry	Process
<p><b>TaqMan® reagents or kits</b></p> <p><b>Description</b> TaqMan reagent-based chemistry uses a fluorogenic probe to enable detection of a specific PCR product as it accumulates during PCR cycles.</p> <p><b>Advantages</b></p> <ul style="list-style-type: none"> <li>Increases specificity with a probe. Specific hybridization between probe and target generates fluorescence signal.</li> <li>Provides multiplex capability.</li> <li>Optimized assays available.</li> <li>Allows 5' -nuclease assay to be carried out during PCR.</li> </ul>	<div style="display: flex; justify-content: space-around;"> <div style="width: 45%;"> <p><b>Polymerization</b></p> <p><b>Step 1:</b> A reporter (R) and a quencher (Q) are attached to the 5' and 3' ends of a TaqMan probe.</p> </div> <div style="width: 45%;"> <p><b>Strand Displacement</b></p> <p><b>Step 1 (continued):</b> When both dyes are attached to the probe, reporter dye emission is quenched.</p> </div> </div> <div style="display: flex; justify-content: space-around; margin-top: 20px;"> <div style="width: 45%;"> <p><b>Cleavage</b></p> <p><b>Step 2:</b> During each extension cycle, the AmpliTaq Gold® DNA polymerase cleaves the reporter dye from the probe.</p> </div> <div style="width: 45%;"> <p><b>Polymerization Completed</b></p> <p><b>Step 3:</b> After being separated from the quencher, the reporter dye emits its characteristic fluorescence.</p> </div> </div>
<p><b>SYBR® Green I reagents</b></p> <p><b>Description</b> Uses SYBR Green I dye, a double-stranded DNA binding dye, to detect PCR products as they accumulate during PCR cycles.</p> <p><b>Advantages</b></p> <ul style="list-style-type: none"> <li>Reduces cost (no probe needed)</li> <li>Amplifies all double-stranded DNA</li> <li>Yields a melting profile of distinct PCR runs</li> <li>Increases signal fluorescence as amplification product length increases.</li> </ul> <p><b>Limitations</b> Binds nonspecifically to all double-stranded DNA sequences. To avoid false positive signals, check for nonspecific product formation using dissociation curve or gel analysis.</p>	<p><b>Step 1: Reaction setup</b> The SYBR® Green I dye fluoresces when bound to double-stranded DNA.</p> <p><b>Step 2: Denaturation</b> When the DNA is denatured, the SYBR® Green I dye is released and the fluorescence is drastically reduced.</p> <p><b>Step 3: Polymerization</b> During extension, primers anneal and PCR product is generated.</p> <p><b>Step 4: Polymerization completed</b> SYBR® Green I dye binds to the double-stranded product, resulting in a net increase in fluorescence detected by the instrument.</p>

Notes

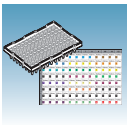

## Selecting One- or Two-Step RT-PCR

When performing Real-Time PCR, you have the option of performing reverse transcription (RT) and PCR in a single reaction (one-step) or in separate reactions (two-step). The reagent configuration you use depends on whether you are performing one-step or two-step RT-PCR:

- Two-step RT-PCR is performed in two separate reactions: first, total RNA is reverse transcribed into cDNA, then the cDNA is amplified by PCR. This method is useful for detecting multiple transcripts from a single cDNA template or for storing cDNA aliquots for later use. AmpErase<sup>®</sup> UNG (uracil-N-glycosylase) enzyme can be used to prevent carryover contamination.

---

**IMPORTANT!** This guide assumes that RQ experiments are designed using two-step RT-PCR. For additional options, refer to the *Real-Time PCR Systems Chemistry Guide*.

---

---

**IMPORTANT!** RQ plates may be run with either standard or Fast thermal cycling conditions. An RQ study must be composed of RQ plates of the same thermal cycling protocol. RQ plates run on standard thermal cycling protocols and RQ plates run on Fast thermal cycling protocols cannot be combined into a single RQ study.

---

- In one-step RT-PCR, RT and PCR take place in one buffer system, which provides the convenience of a single-tube preparation for RT and PCR amplification. However, you cannot use the carryover prevention enzyme, AmpErase<sup>®</sup> UNG, with one-step RT-PCR. For more information about UNG, refer to the *Real-Time PCR Systems Chemistry Guide*.

Notes \_\_\_\_\_

\_\_\_\_\_

\_\_\_\_\_

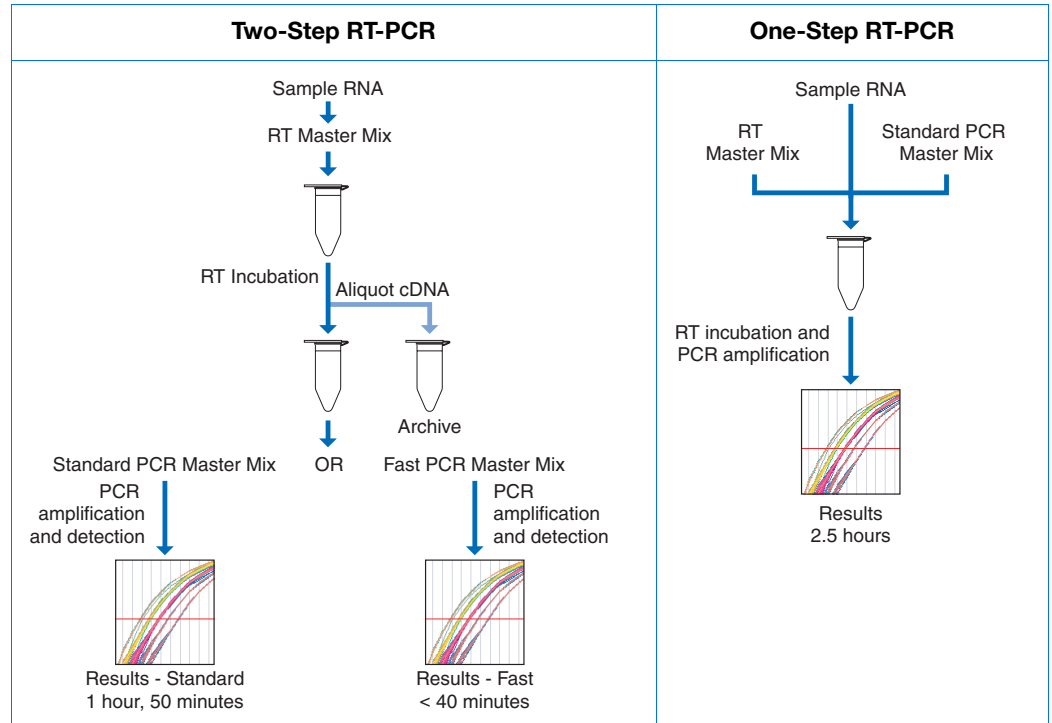
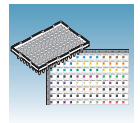

2

Recommended Kits for Two-Step RT-PCR			
Chemistry	Step	Reagent	Part Number
TaqMan reagents or kits	RT	High Capacity cDNA Archive Kit	4322171
	PCR	TaqMan Universal PCR Master Mix	4304437
		TaqMan Fast Universal PCR Master Mix	4352042
SYBR Green I reagents or kits	RT	High Capacity cDNA Archive Kit	4322171
	PCR	SYBR Green Master Mix	4309155
	RT and PCR	SYBR Green RT-PCR Reagents	4310179

### Sample Experiment

Premade probes and primers for all the genes of interest are available from the TaqMan® Gene Expression Assays product line, which uses TaqMan reagent-based chemistry. Two-step RT-PCR is performed using the reagents recommended for TaqMan reagent- or kit-based chemistry in the table above.

Notes

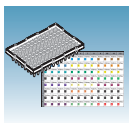

## Choosing the Probes and Primers

Choose probe and primer sets for both your target and endogenous control sequences. Applied Biosystems provides three options for choosing primers and probes:

- **TaqMan<sup>®</sup> Gene Expression Assays** – Provide you with optimized, ready-to-use TaqMan reagent-based 5' -nuclease assays for human, mouse, or rat transcripts. For information on available primer/probe sets, go to:  
<http://www.allgenes.com>
- **TaqMan<sup>®</sup> Custom Gene Expression Assays** – Designs, synthesizes, formulates, and delivers quality-controlled primer and probe sets. Use this service if the assay you need is not currently available. To place an order, contact your Applied Biosystems representative or go to <http://www.allgenes.com>.
- **Primer Express<sup>®</sup> Software** – Helps you design primers and probes for your own quantification assays. For more information about using this software, refer to the *Primer Express Software v3.0 Getting Started Guide* (PN 4362460).

Applied Biosystems provides assay design guidelines that have been developed specifically for quantification assays. When followed, these guidelines provide a reliable system for assay design and optimization. For information about the assay design guidelines, refer to the *Real-Time PCR Systems Chemistry Guide*.

If you ordered TaqMan<sup>®</sup> Gene Expression Assays or TaqMan<sup>®</sup> Custom Gene Expression Assays, probes are already labeled with FAM<sup>™</sup> as a reporter dye. If you design your own assays, you need to specify a reporter dye for your custom probe(s). For singleplex experiments, you can use the same dye for targets and endogenous control(s). For multiplex experiments, the probe for the target is typically labeled with FAM dye and that for the endogenous control with VIC<sup>®</sup> dye.

Notes \_\_\_\_\_



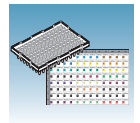

### Sample Experiment

For the example experiment, primers and probes for all the genes being studied are obtained from Applied Biosystems TaqMan® Gene Expression Assays. Each assay consists of two unlabeled PCR primers and a FAM™ dye-labeled TaqMan® MGB probe, provided as a 20X assay mix.

In the example experiment, all target probes are labeled with FAM dye; the endogenous control is also labeled with FAM dye.

The following table provides the gene symbol, gene name, and Applied Biosystems Assay ID number (provided on the Web site) for five of the genes studied in the example experiment, plus the endogenous control.

Gene Symbol	Gene Name	Assay ID #
ACVR1	acrosomal vesicle protein I	Hs00153836_m1
ACVR2	activin A receptor, type II	Hs00155658_m1
CCR2	chemokine (C-C motif) receptor 2	Hs00174150_m1
CD3D	CD3D antigen, delta polypeptide (TiT3 complex)	Hs00174158_m1
FLT4	fms-related tyrosine kinase 4	Hs00176607_m1
GAPDH	glyceraldehyde-3-phosphate dehydrogenase	Hs99999905_m1

Notes \_\_\_\_\_

\_\_\_\_\_

\_\_\_\_\_

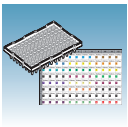

## Chapter 2 Designing an RQ Experiment

*Choosing the Probes and Primers*

Notes \_\_\_\_\_

# Performing Reverse Transcription

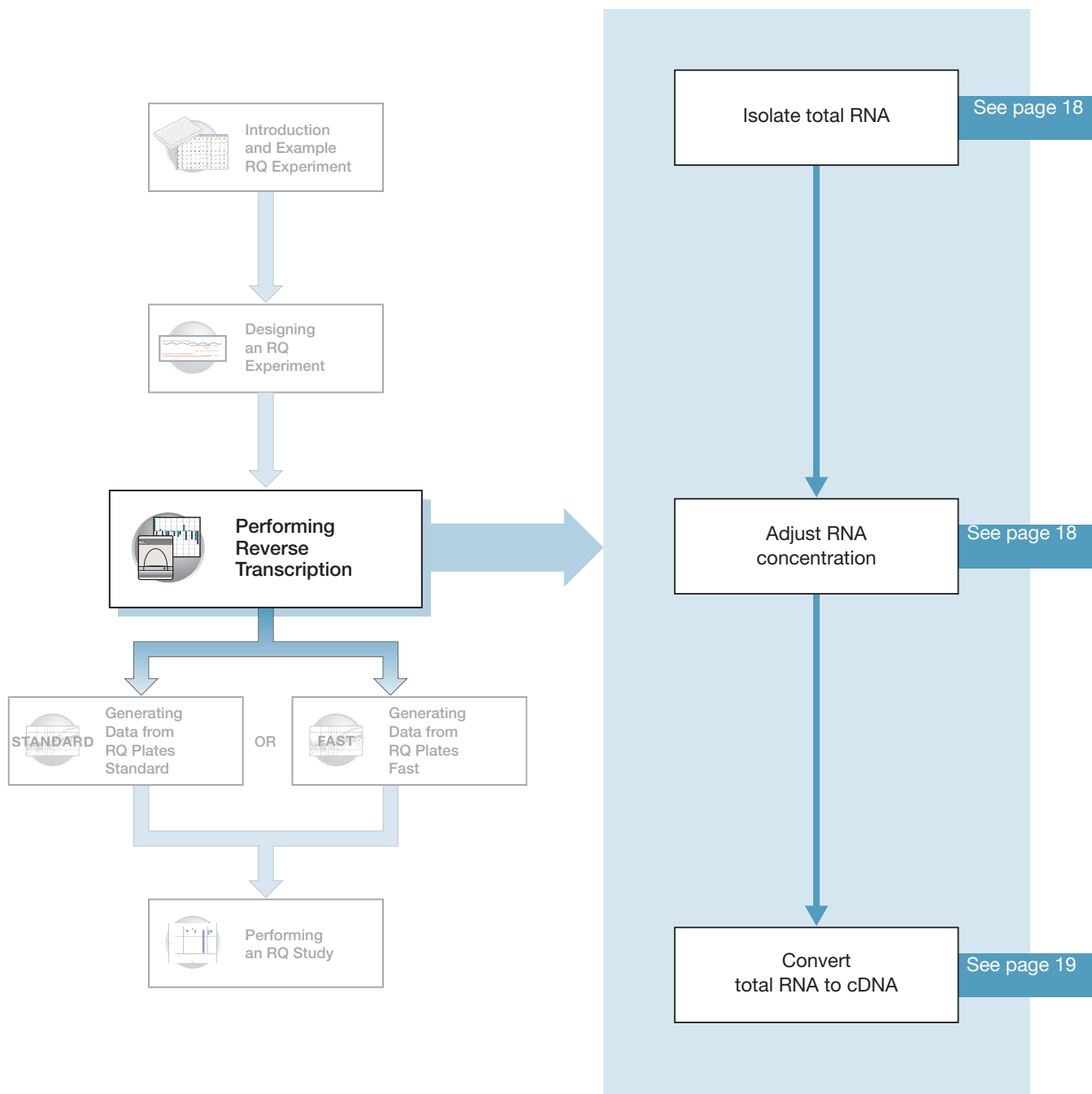
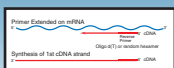

## Notes

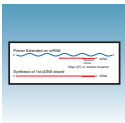

## Guidelines for Preparing RNA

**Isolating RNA** Applied Biosystems supplies several instrument systems and chemistries for RNA isolation from a variety of starting materials, such as blood, tissue, cell cultures, and plant material.

Products	Part Number
ABI PRISM® 6100 Nucleic Acid PrepStation	6100-01
Tempus™ Blood RNA Tubes (For collection, stabilization, and isolation of total RNA in whole blood for gene expression analysis using the 6100 PrepStation)	4342972
<i>Isolation of Total RNA from Whole Blood and from Cells Isolated from Whole Blood Protocol</i>	4332809
<i>Tempus™ Blood RNA Tube and Large Volume Consumables Protocol</i>	4345218
<i>Tissue RNA Isolation: Isolation of Total RNA from Plant and Animal Tissue Protocol</i>	4330252
<i>Isolation of Total RNA from Cultural Cells: ABI PRISM™ 6700 Automated Nucleic Acid Workstation or 6100 Nucleic Acid PrepStation Protocol</i>	4330254
<i>NucPrep® Chemistry: Isolation of Genomic DNA from Animal and Plant Tissue Protocol</i>	4333959
<i>ABI PRISM® TransPrep Chemistry: Purification of gDNA from Filtrates Obtained After the Isolation of RNA from Homogenized Animal or Plant Tissue Samples Protocol</i>	4326965
<i>BloodPrep™ Chemistry: DNA Isolation from Fresh and Frozen Blood, Tissue Culture Cells, and Buccal Swabs on the ABI PRISM® 6100 Nucleic Acid PrepStation Quick Reference Card</i>	4345297

**Quality of RNA** The total RNA you use for RQ experiments should:

- Have an  $A_{260/280}$  greater than 1.9
- Be intact when visualized by gel electrophoresis
- Not contain RT or PCR inhibitors

The *High Capacity cDNA Archive Kit Protocol* (PN 4312169) contains additional guidelines for preparing the RNA template.

### Adjusting the Starting Concentration of Total RNA

The High Capacity cDNA Archive Kit is optimized to convert 0.1 to 10 µg of total RNA to cDNA. Convert enough total RNA so that the final concentration of total RNA converted to cDNA is 10 to 100 ng in 5 µL for each 50-µL PCR reaction.

Notes \_\_\_\_\_

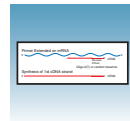

## Converting Total RNA to cDNA

### Using the High Capacity cDNA Archive Kit

Use the High Capacity cDNA Archive Kit (PN 4322171) to perform the first step (RT) in the two-step RT-PCR method. Follow the manual method for converting total RNA into cDNA, as specified in the *High Capacity cDNA Archive Kit Protocol* (PN 4322169).

---

**IMPORTANT!** The protocol is not shipped with the High Capacity cDNA Archive Kit. Download the protocol from

**<http://docs.appliedbiosystems.com/search.taf>**

To search for the document, select **ABI PRISM® 6100 Nucleic Acid PrepStation** in the Product list box, then click **Search** at the bottom of the page. The protocol is listed under the Protocols heading.

---

### Thermal Profile Parameters for RT

The High Capacity cDNA Archive Kit uses the following thermal profile parameters for the RT step.

Step Type	Time	Temperature
HOLD	10 min	25 °C
HOLD	120 min	37 °C

---

**Note:** Thermal cycling conditions for one-step RT-PCR are described on [page 30](#).

---

Notes \_\_\_\_\_

\_\_\_\_\_

\_\_\_\_\_

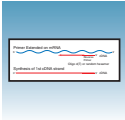

**Storing cDNA** After cDNA conversion, store all cDNA samples at  $-15$  to  $-25$  °C. To minimize repeated freeze-thaw cycles of cDNA, store cDNA samples in aliquots.

 **WARNING** **CHEMICAL HAZARD.**  $10 \times$  RT Buffer may cause eye, skin, and respiratory tract irritation. Read the MSDS, and follow the handling instructions. Wear appropriate protective eyewear, clothing, and gloves.

### Sample Experiment - Standard Plate

For the example experiment, RNA is extracted from the liver, bladder, and kidney tissues of an individual. RNA concentration is determined spectrophotometrically (using  $A_{260}$ ), and the RNA is diluted to a final concentration of  $50$  ng/ $\mu$ L. The RT master mix is prepared as follows, using guidelines from the *High Capacity cDNA Archive Kit Protocol*:

Component	$\mu$ L/Reaction	$\mu$ L/21 Reactions <sup>‡</sup>
10X Reverse Transcription Buffer	10	210
25X dNTPs	4	84
10X random primers	10	210
MultiScribe™ Reverse Transcriptase, 50 U/ $\mu$ L	5	105
Nuclease-free water	21	441
Total per reaction	50	1050

<sup>‡</sup> Each RT reaction is  $100$   $\mu$ L (see below). If you need  $5$   $\mu$ L cDNA for each of  $104$  PCR reactions per tissue (see “[Creating a Relative Quantification \(RQ\) Plate Document](#)” on page 25), you need  $6$  RT reactions per tissue. Extra volume (enough for one additional RT reaction per tissue) is included to account for pipetting losses, as well as extra cDNA for archiving.

The cDNA archive plate is then prepared by pipetting into each well:

- $50$   $\mu$ L of the RT master mix
- $30$   $\mu$ L of nuclease-free water
- $20$   $\mu$ L of RNA sample (bringing the total starting amount of RNA to  $1$   $\mu$ g per  $100$   $\mu$ L reaction)

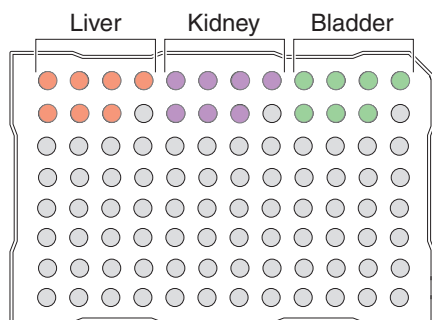

The RNA is then converted to cDNA using the thermal cycling parameters for two-step RT-PCR, as described in “[Thermal Profile Parameters for RT](#)” on page 19.

The cDNA is stored at  $-20$  °C until use.

### Notes



# Generating Data from RQ Plates – 7300 or Standard 7500 System

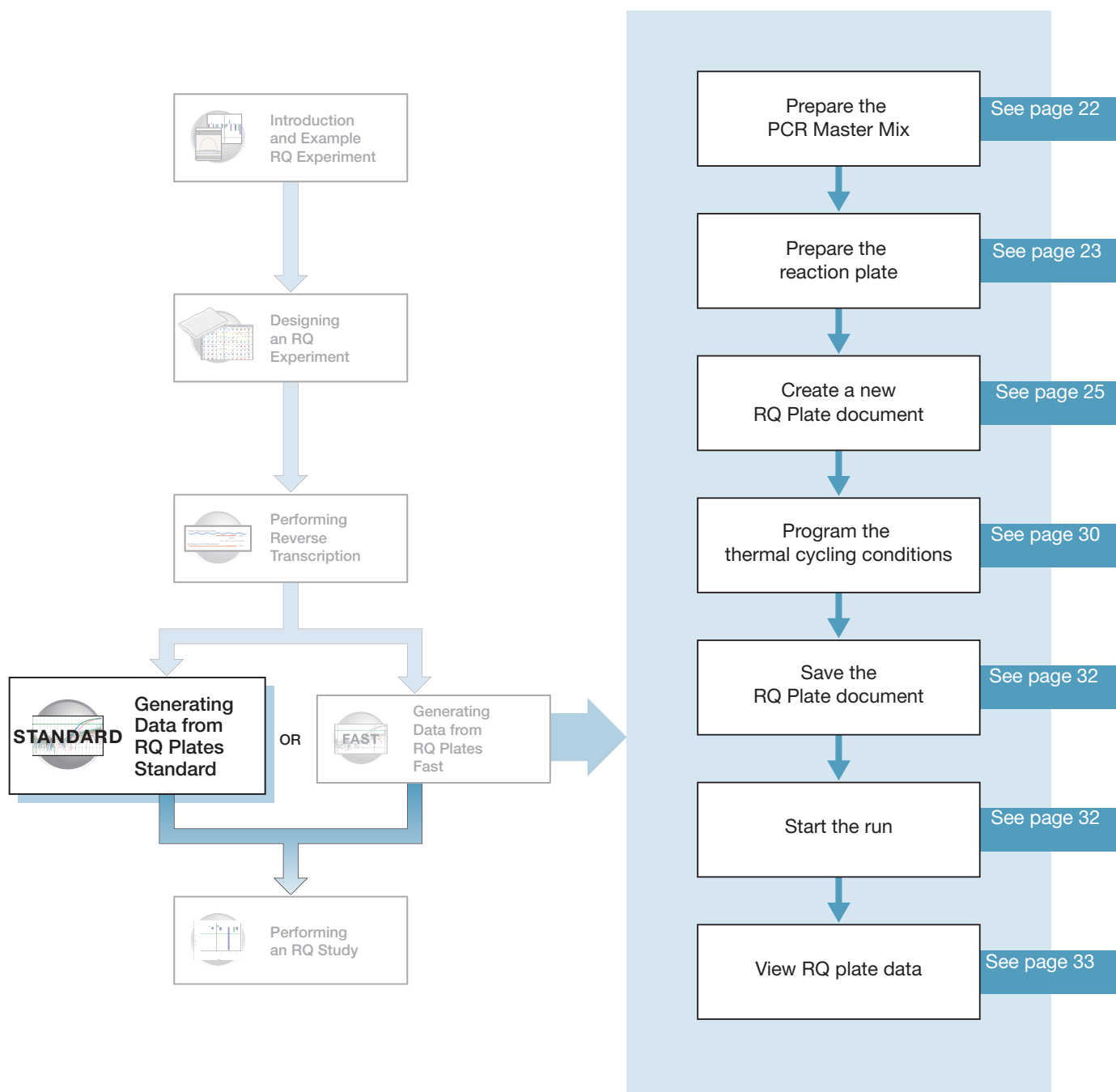

Notes \_\_\_\_\_

## Before You Begin

Check that background and pure-dye runs have been performed regularly to ensure optimal performance of the 7300/7500 system. For more information about calibrating the 7300/7500 system, refer to the Online Help located within the software by clicking the .

## Preparing the PCR Master Mix

The second step (PCR) in the two-step RT-PCR procedure is amplifying the cDNA, which you perform using the TaqMan<sup>®</sup> Universal PCR Master Mix reagents.

The *TaqMan Universal PCR Master Mix Protocol* (PN 4351891) explains how to use the reagents in the kit. The following table lists the universal assay conditions (volume and final concentration) for using the master mix.



**CAUTION** **CHEMICAL HAZARD.** TaqMan Universal PCR Master Mix (2X) No AmpErase UNG may cause eye and skin irritation. Exposure may cause discomfort if swallowed or inhaled. Read the MSDS, and follow the handling instructions. Wear appropriate protective eyewear, clothing, and gloves.

Reaction Component	μL/ Sample	Final Concentration	Universal Conditions
TaqMan <sup>®</sup> Universal PCR Master Mix (2X)	25.0	1X	1X
Forward primer	5.0	50 to 900 nM	900 nM
Reverse primer	5.0	50 to 900 nM	900 nM
TaqMan <sup>®</sup> probe	5.0	50 to 250 nM	250 nM
cDNA sample	5.0	10 to 100 ng	
Nuclease-free water	5.0	—	—
Total	50.0	—	—

If you design probes and primers using Primer Express software, they must be optimized to work with the universal assay conditions, using the volumes listed in the table above. All TaqMan<sup>®</sup> Custom Gene Expression Assays and TaqMan<sup>®</sup> Gene Expression Assays are formulated so that the final concentration of the primers and probes are within the recommended values.

Notes \_\_\_\_\_





## Preparing the Reaction Plate

### Standard vs. Fast Plates

**IMPORTANT!** Make sure that you use the standard Optical 96-Well Plate on the 7500 Real-Time PCR system. Optical 96-Well Fast Plates will *not* fit into the standard block correctly and will result in loss of data.

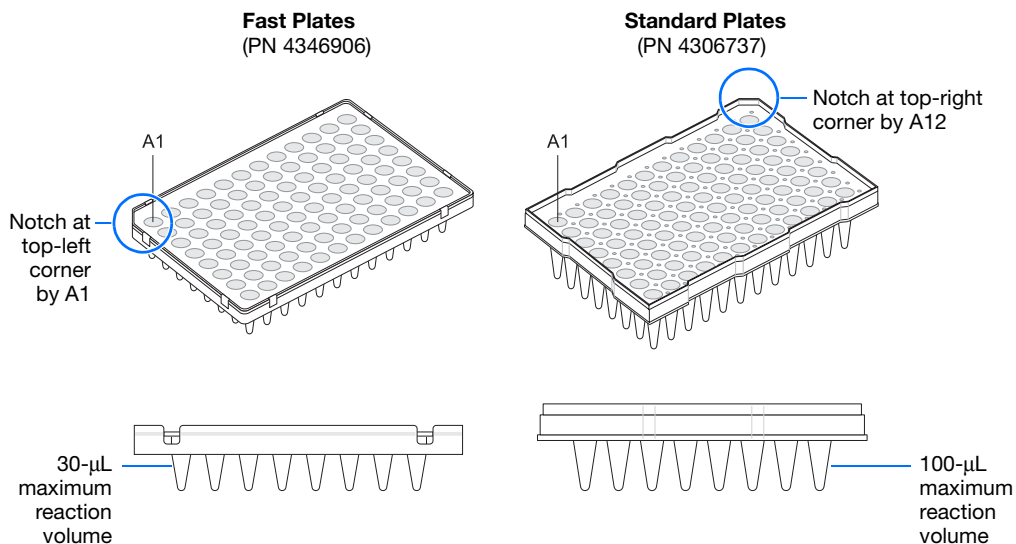

1. Label the reaction plates, ensuring that you include an endogenous control for each sample type (for example, each tissue in a study comparing multiple tissues). If samples are spread across multiple plates, each plate must have an endogenous control. Additionally, every plate must include an endogenous control for every sample type on the plate.
2. Into each well of the reaction plate, add 50 µL of the appropriate PCR master mix.
3. Keep the reaction plates on ice until you are ready to load them into the 7300/7500 system.

Notes \_\_\_\_\_

### Sample Experiment

Primers and probes for the example RQ experiment are obtained from the TaqMan Gene Expression Assays product line and are provided as a 20X Gene Expression Assay Mix. The PCR master mix is prepared as follows:

Reaction Component	$\mu\text{L}/\text{Sample}$	$\mu\text{L}/ 5 \text{ Reactions}^{\S}$	Final Concentration
TaqMan® Universal PCR Master Mix (2X)	25.0	125.0	1X
20X Gene Expression Assay Mix <sup>‡</sup>	2.5	12.5	1X
cDNA sample	5.0	25.0	50 ng (for the 50- $\mu\text{L}$ reaction)
Nuclease-free water	17.5	87.5	—
Total	50.0	250	—

<sup>‡</sup> Contains forward and reverse primers and labeled probe.

<sup>§</sup> 24 master mixes are prepared, one for each of 23 genes plus the endogenous control. Volume for five reactions (4 replicates plus extra) to account for pipetting losses.

Samples and endogenous controls are arranged on three plates as shown below. 50  $\mu\text{L}$  of PCR master mix containing cDNA are added to each well.

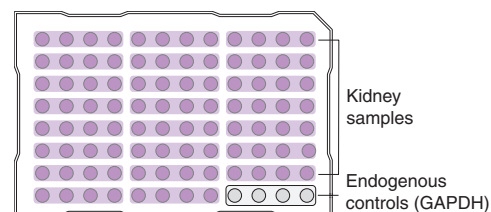
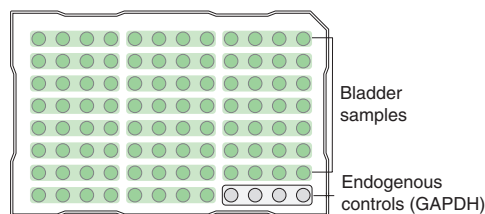
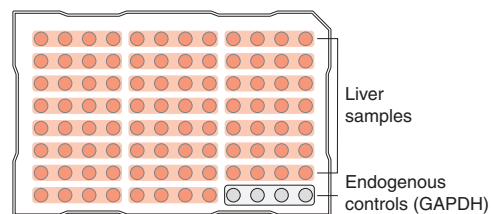

The reactions are kept on ice until the plates are loaded on the 7300/7500/7500 Fast system.

### Notes



## Creating a Relative Quantification (RQ) Plate Document

**Overview** An RQ Plate document stores data collected from an RQ run for a single plate. There must be one RQ Plate document for every RQ plate. RQ Plate documents also store other information, including sample names and detectors.

**Run Setup Requirements** For each RQ plate document that you create, specify detectors, endogenous controls, and detector tasks:

- A detector is a virtual representation of a gene-specific nucleic acid probe reagent used in assays. You specify which detector to use for each target sequence. [Appendix A, “Creating Detectors,” on page 79](#) explains how to create detectors.

---

**IMPORTANT!** To conduct a comparative analysis of the data in a study, all the plates in the study must contain a common set of detectors.

---

- An endogenous control(s) is defined in [“Specifying the Components of an RQ Experiment” on page 9](#). If your experiment consists of multiple plates, each plate must have at least one endogenous control with at least three replicates. If your experiment consists of a single plate with multiple samples, there must be an endogenous control for each sample. All plates in an RQ experiment must use the same endogenous control (for example, GAPDH).
- A detector task specifies how the software uses the data collected from the well during analysis. You apply one of two tasks to each detector in each well of a plate document.

Task	Symbol	Apply to detectors of...
Target	T	Wells that contain PCR reagents for the amplification of target sequences.
Endogenous Control	E	Wells that contain reagents for the amplification of the endogenous control sequence.

Notes \_\_\_\_\_  
\_\_\_\_\_  
\_\_\_\_\_

## Creating an RQ Plate Document

You can enter sample information into a new plate document, import sample information from existing plate documents, or use a template document to set up new plate documents. This section describes setting up new plate documents. Refer to the Online Help for information about importing sample information or using template documents.

To create a new plate document:

1. Select **Start > Programs > Applied Biosystems 7300/7500/7500 Fast > Applied Biosystems 7300/7500/7500 Fast SDS Software** (  ) to start the SDS Software 1.3.1.
2. Select **File > New**.
3. In the Assay drop-down list of the New Document Wizard, select **Relative Quantification (ddCt) Plate**. Accept the default settings for Container and Template (**96-Well Clear** and **Blank Document**).

---

**IMPORTANT!** You cannot use RQ Plate documents for AQ assays and vice versa. You cannot use RQ Plate documents to perform relative quantification using the relative standard curve method. The information stored in AQ and RQ Plate documents is not interchangeable.

---

4. Enter a name in the Default Plate Name field, or accept the default.
5. Click **Next >**.

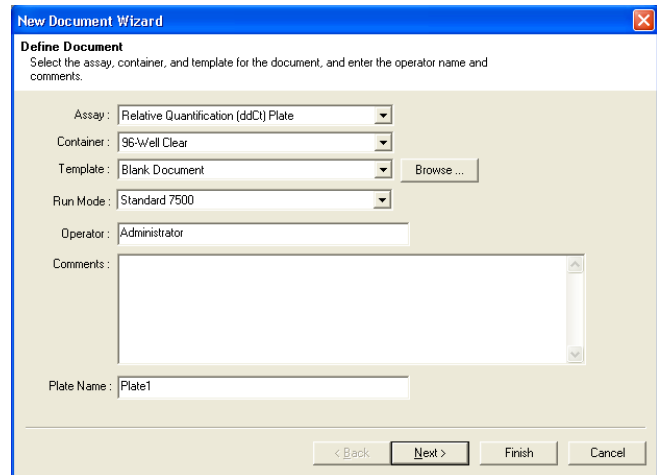

Notes \_\_\_\_\_

\_\_\_\_\_

\_\_\_\_\_



6. Select detectors to add to the plate document.

- a. Click to select a detector. (Ctrl-click to select multiple detectors.) If no detectors are listed in the Detector Manager, click **New Detector** to open the New Detector dialog box. For more information about creating new detectors, refer to [Appendix A, “Creating Detectors,”](#) on page 79.
- b. Click **Add>>**. The detectors are added to the plate document.

**Note:** To remove a detector from the Detectors in Document panel, select the detector, then click **Remove**.

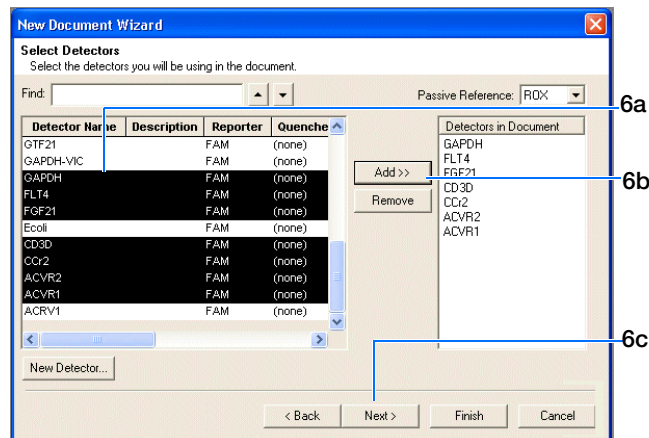

- c. Click **Next >**.

7. Specify the detectors and tasks for each well.

- a. Click a well (or group of wells, for replicates) to select it.
- b. Click to select the detector(s) for the well.
- c. Click under the Task column to assign the detector task.
- d. Select **Use**.
- e. Click **Finish**.

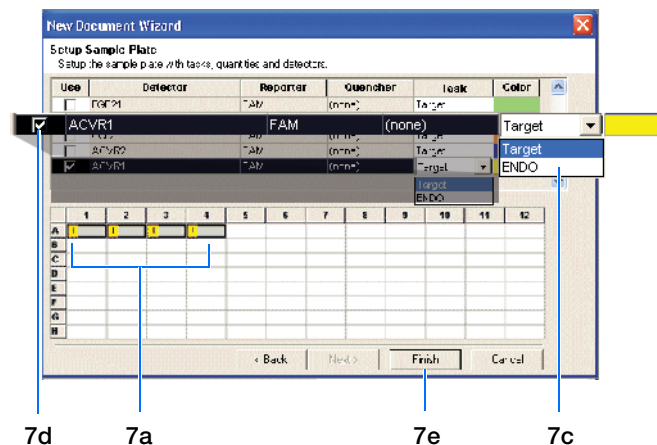

You cannot add RQ plates to RQ studies unless you have specified sample names, as indicated in the message shown to the right. Click **OK**.

The SDS Software 1.3.1 creates the plate document and displays the Well Inspector.

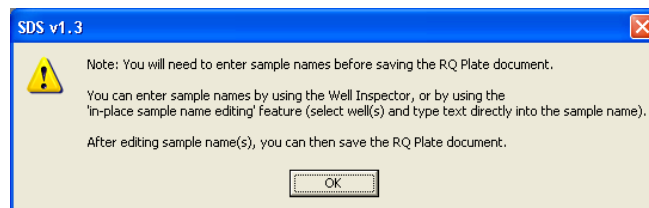

Notes

8. Enter the sample names.
  - a. In the Well Inspector, click a well or click-drag to select replicate wells.
  - b. Enter the sample name.
  - c. If necessary, change the setting for the Passive Reference dye. (By default, the ROX™ dye is selected.)
  - d. Repeat [steps a through c](#) until you specify sample names and passive reference dyes for all the wells on the plate.

---

**IMPORTANT!** If your experiment does not use all the wells on a plate, do not omit the wells from use at this point. You can omit unused wells after the run. For information about omitting unused wells, refer to the Online Help.

---

**Note:** You can change the sample setup information (sample name, detector, task) after a run is complete, if necessary.

---

- e. Close the Well Inspector.
9. Verify the information on each well in the Setup tab.

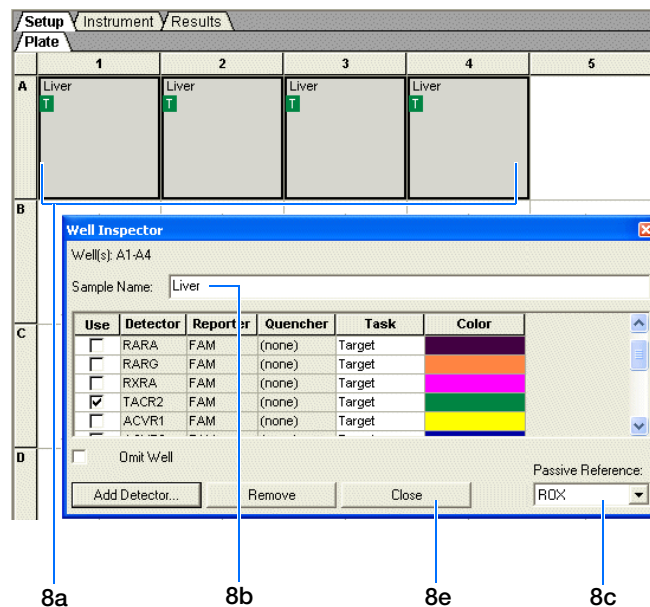



## Sample Experiment

In the example RQ experiment, the samples for each of the three tissues (liver, kidney, and bladder) are loaded on three separate plates. Consequently, three RQ Plate documents are created, one for each of the sample plates.

Because the experiment is singleplex, there is only one sample—either a target or endogenous control—in each well. Each well is associated with a detector (indicated by the colored squares). Additionally, each well is assigned a detector task—T (target) or E (endogenous control).

The figure below shows the example RQ Plate document after sample names, detectors, and detector tasks are assigned for each well in the liver plate.

The screenshot shows a software interface for an RQ Plate document. The main area is a 96-well plate grid with columns 1-12 and rows A-H. Each well contains the text 'Liver' and a small colored square. The color of the square indicates the detector task: 'T' (Target) is shown in purple, blue, yellow, orange, and red; 'E' (Endogenous control) is shown in green. Two blue arrows point to the grid: one to the text 'Liver' in well C4, labeled 'Sample name', and another to the colored square in well E4, labeled 'Detector task and color'.

Plate	1	2	3	4	5	6	7	8	9	10	11	12
A	Liver	Liver	Liver	Liver	Liver	Liver	Liver	Liver	Liver	Liver	Liver	Liver
B	Liver	Liver	Liver	Liver	Liver	Liver	Liver	Liver	Liver	Liver	Liver	Liver
C	Liver	Liver	Liver	Liver	Liver	Liver	Liver	Liver	Liver	Liver	Liver	Liver
D	Liver	Liver	Liver	Liver	Liver	Liver	Liver	Liver	Liver	Liver	Liver	Liver
E	Liver	Liver	Liver	Liver	Liver	Liver	Liver	Liver	Liver	Liver	Liver	Liver
F	Liver	Liver	Liver	Liver	Liver	Liver	Liver	Liver	Liver	Liver	Liver	Liver
G	Liver	Liver	Liver	Liver	Liver	Liver	Liver	Liver	Liver	Liver	Liver	Liver
H	Liver	Liver	Liver	Liver	Liver	Liver	Liver	Liver	Liver	Liver	Liver	Liver

### Notes

## Specifying Thermal Cycling Conditions and Starting the Run

### Default Thermal Cycling Conditions for PCR

If you selected the two-step RT-PCR method for your RQ experiment (recommended), you have already completed the RT step and are ready to PCR amplify cDNA.

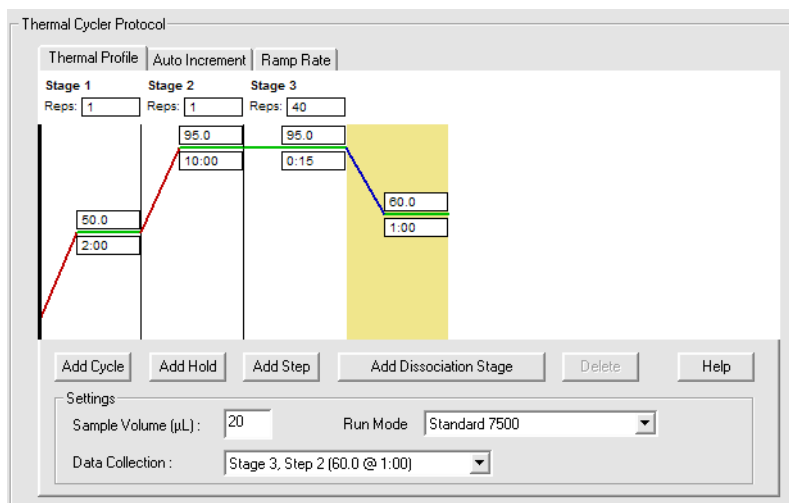

The default thermal cycling conditions for the PCR step of the procedure, shown in the following table, should appear in the Instrument tab.

Times and Temperatures (Two-step RT-PCR)				
1) RT Step	HOLD	HOLD	* For reference only. RT is complete at this point.	
	10 min @ 25 °C	120 min @ 37 °C		
2) PCR Step	Initial Steps		PCR (Each of 40 cycles)	
	AmpErase® UNG Activation	AmpliTaq Gold® DNA Polymerase Activation	Melt	Anneal/Extend
	HOLD	HOLD	CYCLE	
	2 min @ 50 °C	10 min @ 95 °C	15 sec @ 95 °C	1 min @ 60 °C

Notes \_\_\_\_\_





## Thermal Cycling Conditions for One-Step RT-PCR

If you select the one-step RT-PCR method, cDNA generation and amplification take place simultaneously at this point in the workflow.

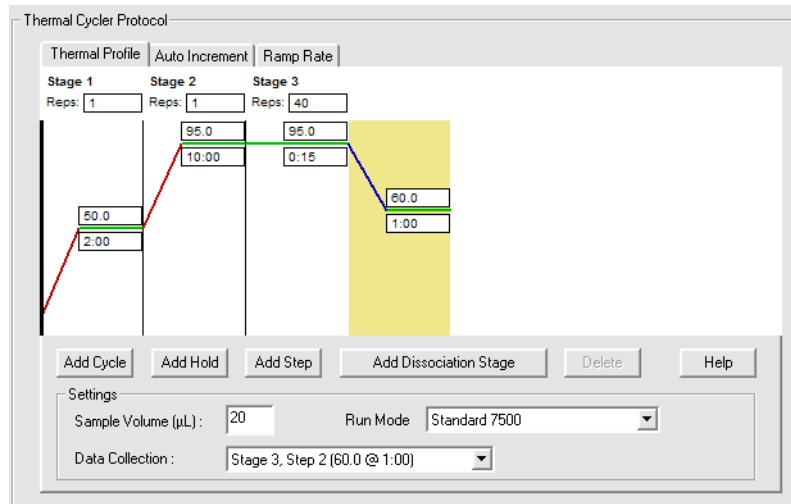

The following table shows the thermal cycling conditions for one-step RT-PCR experiments.

**Note:** Refer to the Online Help for instructions on modifying thermal cycling parameters.

Times and Temperatures (One-step RT-PCR)			
Initial Steps		PCR (Each of 40 Cycles)	
Reverse Transcription	AmpliTaq® Gold DNA Polymerase Activation	Melt	Anneal/Extend
HOLD	HOLD	CYCLE	
30 min @ 48 °C	10 min @ 95 °C	15 sec @ 95 °C	1 min @ 60 °C

Notes \_\_\_\_\_  
 \_\_\_\_\_  
 \_\_\_\_\_

To specify thermal cycling conditions and start the run:

### 1. Select the **Instrument** tab.

By default, the standard PCR conditions for the PCR step of the two-step RT-PCR method are displayed.

### 2. Verify that:

- For two-step RT-PCR, the default PCR thermal cycling conditions are set.
- For one-step RT-PCR, you set the thermal cycling parameters as shown above.
- Sample volume is 50  $\mu$ L.
- 9600 Emulation is selected.

**Note:** If you are using SYBR<sup>®</sup> Green I reagent chemistry and you want to determine if there is contamination or if you want to determine the dissociation temperature, create a separate Dissociation assay or template. Refer to the Online Help for more information.

**Note:** In the 7300 instrument, the 9600 Emulation feature is not available.

### 3. Select **File > Save As**, enter a name for the RQ Plate document, then click **Save**.

### 4. Load the plate into the instrument.

**Note:** 7300 and 7500 standard plates are notched in the A12 position at the top-right; Fast plates are notched in the A1 position at the top-left.

### 5. Click **Start**.

As the instrument performs the PCR run, it displays real-time status information in the Instrument tab and records the fluorescence emissions.

After the run, a message indicates whether or not the run is successful.

All data generated during the run are saved to the RQ Plate document that you saved in [step 3](#).

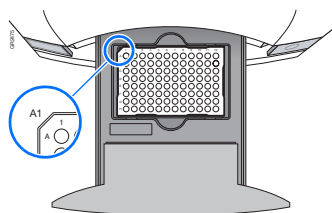
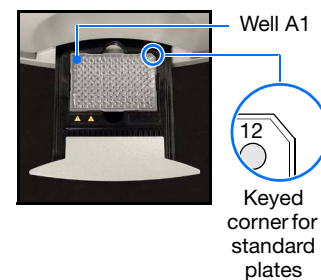
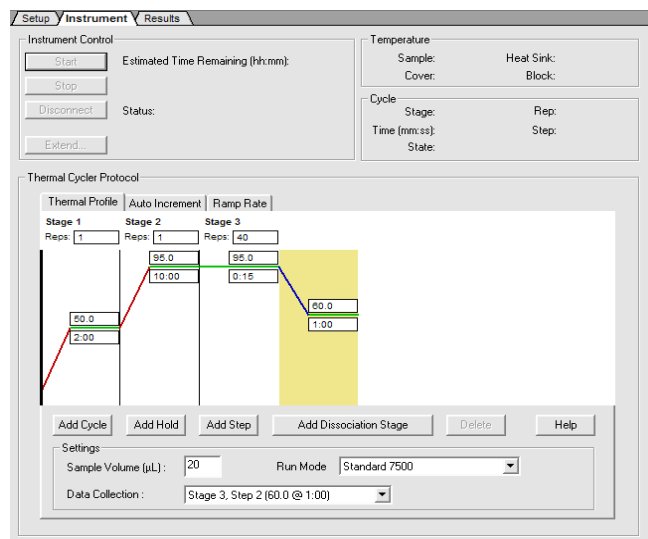

## Notes

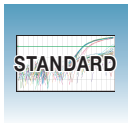

## Analyzing and Viewing RQ Plate Data

### Starting the Analysis

To analyze RQ Plate data after the run, click or select **Analysis > Analyze**. The SDS Software 1.3.1 mathematically transforms the raw fluorescence data to establish a comparative relationship between the spectral changes in the passive reference dye and those of the reporter dyes. Based on that comparison, the software generates four result views: Plate, Spectra, Component, and Amplification Plot.

### About the Results Tab

In the Results tab, you can view the results of the run and change the parameters. For example, you can omit samples or manually set the baseline and threshold. If you change any parameters, you should reanalyze the data.

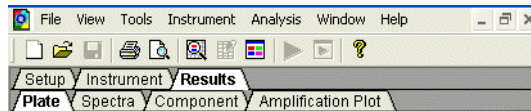

The Results tab has four secondary tabs, each of which is described below. Details are provided in the Online Help.

- To move between views, click a tab.
- To select all 96 wells on a plate, click the upper-left corner of the plate.

	1	2	3	4	5	6
A	Liver T 6.42	Liver T 6.44	Liver T 6.43	Liver T 6.66	Liver T 5.34	Liver T 5.31
B	Liver T 5.87	Liver T 5.93	Liver T 5.95	Liver T 5.97	Liver T 6.52	Liver T 6.28

- To adjust graph settings, double-click the y- or x-axes of a plot to display the Graph Settings dialog. The adjustable settings depend on which plot you are viewing.

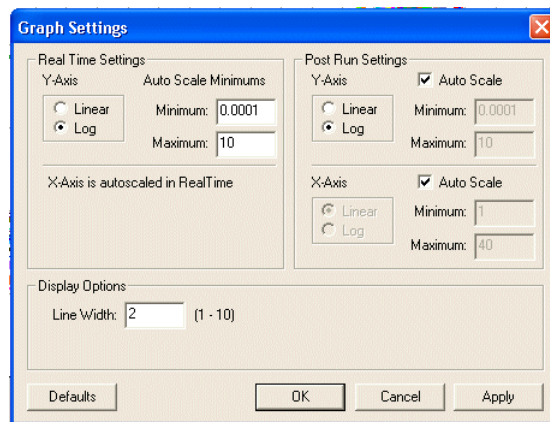

### Notes

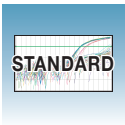

**Plate Tab** Displays the results data of each well, including the:

- Sample name and detector task and color for each well
- Calculated  $R_n$  value

Setup Instrument Results										
Plate Spectra Component Amplification Plot										
	1	2	3	4	5	6	7	8	9	10
A	Liver T 6.42	Liver T 6.44	Liver T 6.43	Liver T 6.66	Liver T 5.34	Liver T 5.31	Liver T 5.23	Liver T 5.10	Liver T 7.83	Liver T 7.76
B	Liver T 5.87	Liver T 5.93	Liver T 5.95	Liver T 5.97	Liver T 6.52	Liver T 6.28	Liver T 6.36	Liver T 6.72	Liver T 2.46	Liver T 2.59
C	Liver T 6.81	Liver T 6.83	Liver T 6.91	Liver T 6.71	Liver T 4.68	Liver T 4.84	Liver T 4.70	Liver T 4.76	Liver T 6.38	Liver T 6.18
D	Liver T 5.94	Liver T 6.09	Liver T 6.18	Liver T 6.22	Liver T 7.01	Liver T 6.94	Liver T 6.97	Liver T 7.00	Liver T 6.85	Liver T 6.79
E	Liver T 6.75	Liver T 6.96	Liver T 7.10	Liver T 7.31	Liver T 5.18	Liver T 5.15	Liver T 5.10	Liver T 5.14	Liver T 5.17	Liver T 5.18

**Spectra Tab** Displays the fluorescence spectra of selected wells.

- The Cycles slider allows you to see the spectra for each cycle by dragging it with the pointer.
- The Cycle # text box shows the current position of the slider.

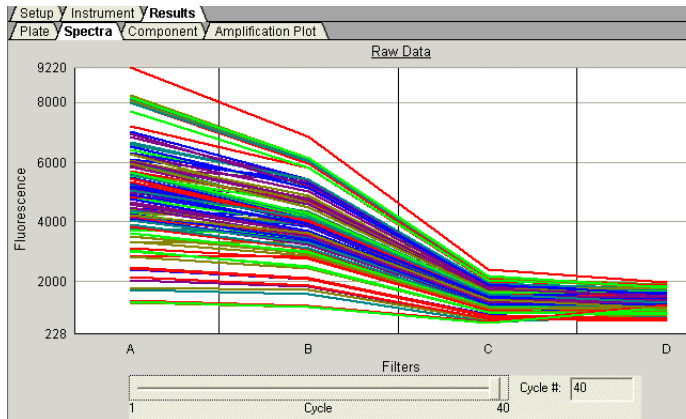

Notes

**Component Tab** Displays the complete spectral contribution of each dye in a selected well over the duration of the PCR run. Only the first selected well is shown at one time.

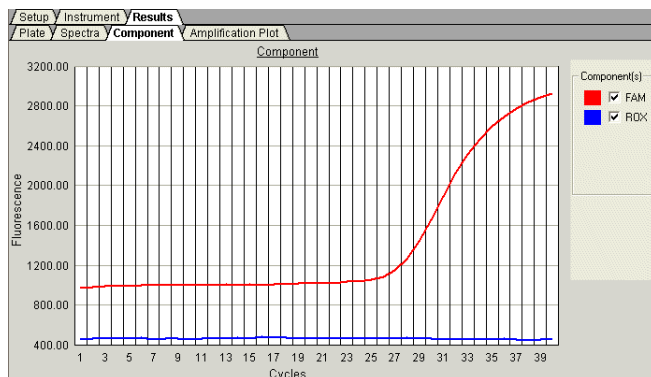

**Note:** If you are using TaqMan<sup>®</sup> products, three components (ROX<sup>™</sup> dye, reporter dye, and TAMRA<sup>™</sup> dye-labelled quencher) are displayed in the Component tab. If you are using TaqMan<sup>®</sup> MGB products, only two components (ROX and reporter dyes) are displayed, as shown.

**Amplification Plot Tab** Displays a plot of  $R_n$  as a function of cycle number for the selected detector and well(s).

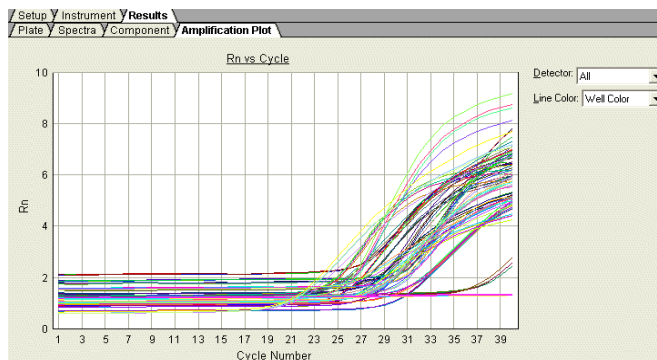

**Reanalyzing Data** Raw fluorescence data (spectra),  $R_n$  values, and well information (sample name, detector, and detector task) are saved in an RQ plate document.

If you decide to omit wells or change well information after a run is complete, you must reanalyze the data.

**Note:** After the software analyzes data, the Analyze button is disabled (▶). Whenever you change a setting that requires reanalysis, the Analyze button is enabled (▶).

Notes

## Exporting RQ Plate Data

You can export numeric data from RQ plates into text files, which can then be imported into spreadsheet applications such as Microsoft Excel.

1. Select **File > Export**, then select the data type to export:
  - **Sample Setup** (\*.txt)
  - **Calibration Data** (\*.csv)
  - **Spectra** (\*.csv)
  - **Component** (\*.csv)
  - **Rn** (\*.csv)

Typically, you export sample setup data for newly created and newly run plates; other data types are exported for existing plates.

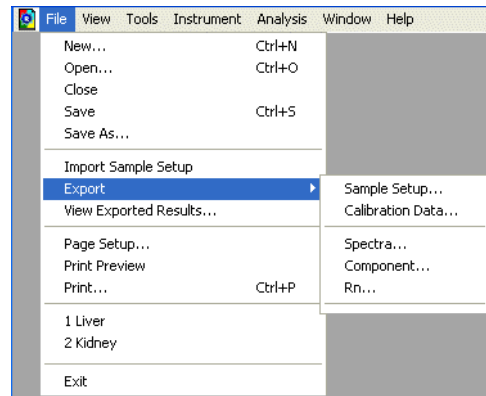

2. Enter a file name for the export file.

---

**Note:** The name of the dialog box depends on the type of data you want to export.

---

3. Click **Save**.

Notes \_\_\_\_\_

\_\_\_\_\_

\_\_\_\_\_



# Generating Data from RQ Plates – 7500 Fast System

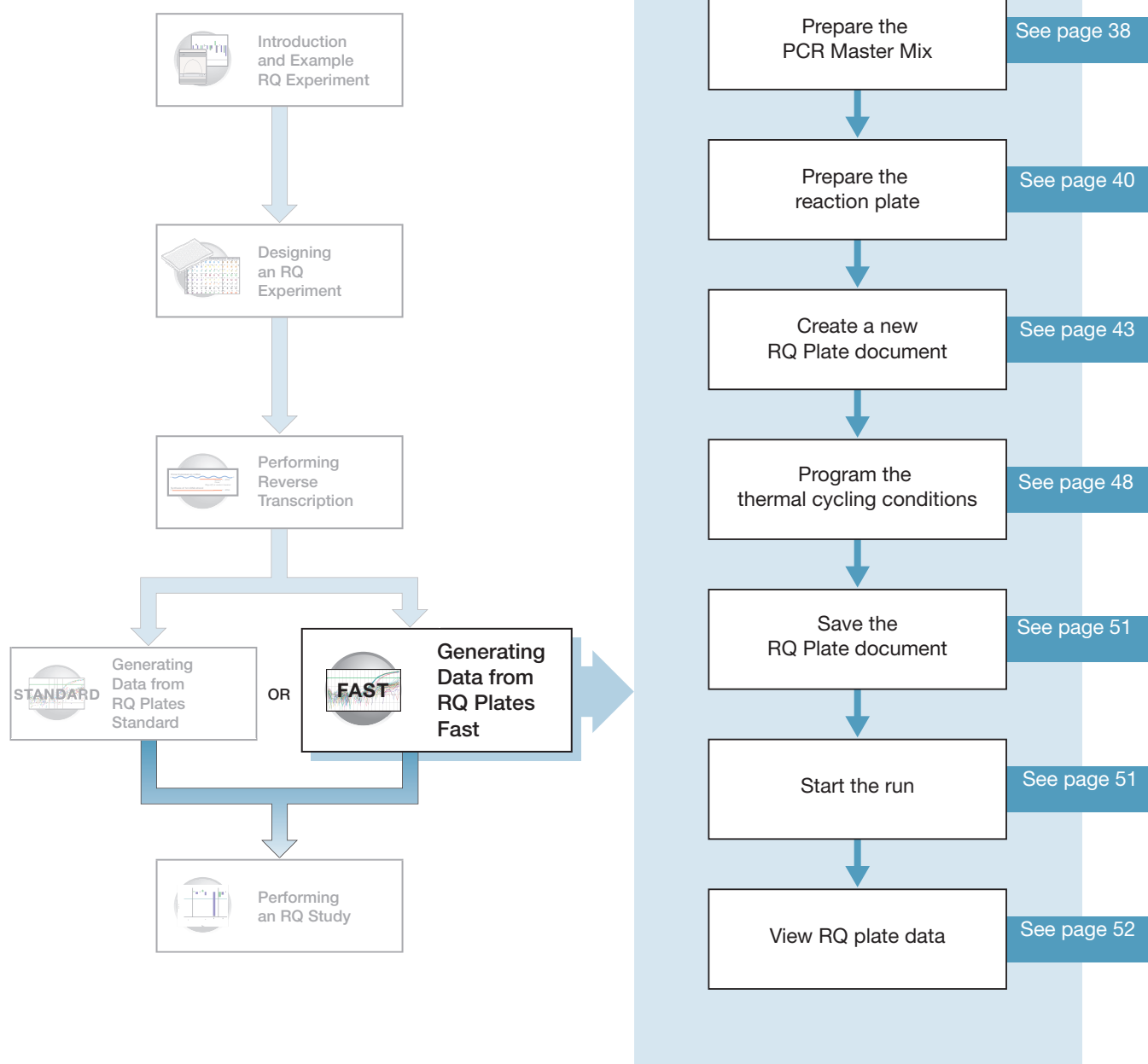

Notes \_\_\_\_\_

\_\_\_\_\_

\_\_\_\_\_

## Before You Begin

Check that background and pure-dye runs have been performed regularly to ensure optimal performance of the 7500 Fast system. For more information about calibrating the 7500 Fast system, refer to the Online Help.

### Fast System Requirements

- 7500 Fast System with fast hardware and software:
  - Sequence Detection Systems Software v1.3 or higher
- Fast reagents and plastics:
  - 7500 Fast System 96-Well Spectral Calibration Kit 1 (PN 4360788)
  - 7500 Fast System 96-Well Spectral Calibration Kit 2 (PN 4362201)
  - Optical 96-Well Fast Thermal Cycling Plate with Barcode (code 128) (PN 4346906)
  - TaqMan<sup>®</sup> RNase P Fast 96-Well Instrument Verification Plate (PN 4351979)
  - TaqMan<sup>®</sup> Fast Universal PCR Master Mix (2X), No AmpErase<sup>®</sup> UNG (PN 4352042)
  - TaqMan<sup>®</sup> Gene Expression Assays (PN 4331182)

---

**IMPORTANT!** A single RQ study cannot combine RQ plates run under different thermal cycling conditions.

---

## Preparing the PCR Master Mix

The second step (PCR) in the two-step RT-PCR procedure is amplifying the cDNA. Perform this step using the TaqMan<sup>®</sup> Universal PCR Master Mix reagents. Users of the 7300/7500 system must use standard TaqMan *Universal PCR Master Mix (2x)* for an approximately 2 hour run time. Users of the 7500 Fast System can choose either the *TaqMan Universal PCR Master Mix (2x)* or *TaqMan Fast Universal PCR Master Mix (2x)*; use of the *TaqMan Fast Universal PCR Master Mix (2x)* allows for a run time of fewer than 40 minutes. For further information on the use of Fast Master Mix, refer to *TaqMan Fast Universal PCR Master Mix Protocol* (PN 4351891).

---

**IMPORTANT!** If you are using *TaqMan Fast Universal PCR Master Mix*, you must start the run within 4 hours of preparing the plate.

---



**CAUTION** **CHEMICAL HAZARD.** TaqMan<sup>®</sup> Fast Universal PCR Master Mix (2X) No AmpErase<sup>®</sup> UNG may cause eye and skin irritation. Exposure may cause discomfort if swallowed or inhaled. Read the MSDS, and follow the handling instructions. Wear appropriate protective eyewear, clothing, and gloves.

---

Notes \_\_\_\_\_

\_\_\_\_\_

\_\_\_\_\_





Probes and primers you design using Primer Express software, must be optimized to work with the universal assay conditions, using the volumes listed in the following table. All TaqMan<sup>®</sup> Custom Gene Expression Assays and TaqMan<sup>®</sup> Gene Expression Assays are formulated so that the final concentration of the primers and probes are within the recommended values.

Reaction Component	μL/ Sample	Final Concentration
TaqMan <sup>®</sup> Fast Universal PCR Master Mix (2X)	10.0	1X
Forward primer	2.0	50 to 900 nM
Reverse primer	2.0	50 to 900 nM
TaqMan <sup>®</sup> probe	2.0	50 to 250 nM
cDNA sample	2.0	10 to 100 ng
Nuclease-free water	20	—
Total	20.0	—

Notes \_\_\_\_\_

## Preparing the Reaction Plate

### Fast vs. Standard Plates

**IMPORTANT!** Make sure that you use the Optical 96-Well Fast Plate on the 7500 Fast System. Standard plates will not function properly and may be crushed when using the 96-Well Fast Block.

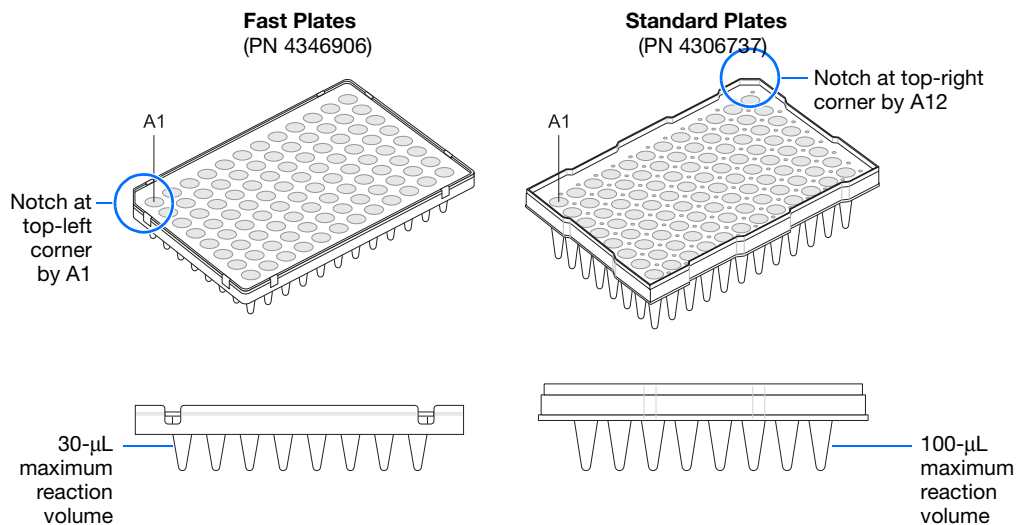



### To Prepare the Reaction Plate:

1. Label the reaction plates, ensuring that you include an endogenous control for each sample type (for example, each tissue in a study comparing multiple tissues). If samples are spread across multiple plates, each plate must have an endogenous control. Additionally, every plate must include an endogenous control for every sample type on the plate.
2. Into each well of the reaction plate, add 20 µL into each well of the low head space reaction plate of the appropriate PCR master mix.
3. Seal the reaction plate with an optical adhesive cover:
  - ABI PRISM® Optical Adhesive Cover, quantity 100 (PN 4311971)
  - Optical Adhesive Cover, quantity 25 (PN 4360954)
4. Centrifuge the plate briefly.
5. Verify that each reaction is positioned in the bottom of the well.

Notes \_\_\_\_\_

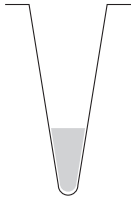
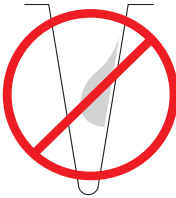

Correct Position	Incorrect Positions	
 <p data-bbox="542 516 818 600">The reaction is positioned correctly in the bottom of the well.</p>	 <p data-bbox="852 516 1128 600">The reaction lies on the side wall because the plate was not centrifuged.</p>	 <p data-bbox="1164 516 1440 653">An air bubble lies at the bottom of the well because the plate was not centrifuged with sufficient force or for sufficient time.</p>

---

**IMPORTANT!** Ensure all reaction is positioned correctly in the bottom of the well before starting a run. Failure to do so will impact the quality of data.

---

6. Place the reaction plates on ice until you are ready to load them into the 7500 Fast system.

Notes \_\_\_\_\_

### Sample Experiment

Primers and probes for the example RQ experiment are obtained from the TaqMan® Gene Expression Assays product line and are provided as a 20X Gene Expression Assay Mix. The PCR master mix is prepared as follows:

**CAUTION CHEMICAL HAZARD.** TaqMan Universal PCR Master Mix may cause eye and skin irritation. Exposure may cause discomfort if swallowed or inhaled. Read the MSDS, and follow the handling instructions. Wear appropriate protective eyewear, clothing, and gloves.

Reaction Component	μL/ Sample	μL/ 5 Reactions <sup>§</sup>	Final Concentration
TaqMan Fast Universal PCR Master Mix (2X)	10	50	1X
20X TaqMan® Gene Expression Assay Mix <sup>‡</sup>	1	5	1X
cDNA sample	9	45	50 ng (for the 50-μL reaction)
Nuclease-free water			—
Total	20	100	—

<sup>‡</sup> Contains forward and reverse primers and labeled probe.

<sup>§</sup> 24 master mixes are prepared, one for each of 23 genes plus the endogenous control. Volume for five reactions (4 replicates plus extra) to account for pipetting losses.

Samples and endogenous controls are arranged on three plates as shown below. 20 μL of Fast PCR master mix containing cDNA are added to each well.

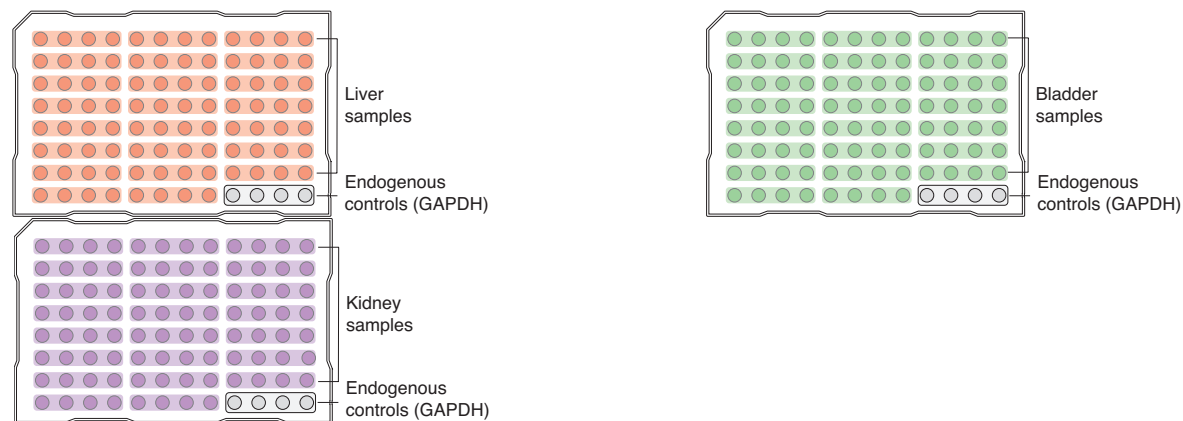

The reactions are kept on ice until the plates are loaded on the 7500 Fast system.

**Note:** To ensure optimal results, run the reaction plate as soon as possible after completing the reaction setup. If you cannot run a reaction plate within 2 hours after completing the reaction setup, refrigerate or freeze the reaction plate until you can load and run it on the 7500 Fast instrument.

### Notes



# Creating a Relative Quantification (RQ) Plate Document

**Overview** An RQ Plate document stores data collected from an RQ run for a single plate. There must be one RQ Plate document for every RQ plate. RQ Plate documents also store other information, including sample names and detectors.

---

**IMPORTANT!** RQ plates run with standard thermal cycling conditions. Fast thermal cycling conditions cannot be combined into a single RQ study.

---

## Run Setup Requirements

For each RQ plate document that you create, specify detectors, endogenous controls, and detector tasks:

- A detector is a virtual representation of a gene-specific nucleic acid probe reagent used in assays. You specify which detector to use for each target sequence. [Appendix A](#) explains how to create detectors.

---

**IMPORTANT!** To conduct a comparative analysis of the data in a study, all the plates in the study must contain a common set of detectors.

---

- An endogenous control(s) is defined in “[Specifying the Components of an RQ Experiment](#)” on page 9. If your experiment consists of multiple plates, each plate must have at least one endogenous control with at least three replicates. If your experiment consists of a single plate with multiple samples, there must be an endogenous control for each sample. All plates in an RQ experiment must use the same endogenous control (for example, GAPDH).
- A detector task specifies how the software uses the data collected from the well during analysis. You apply one of two tasks to each detector in each well of a plate document.

Task	Symbol	Apply to detectors of...
Target	T	Wells that contain PCR reagents for the amplification of target sequences.
Endogenous Control	E	Wells that contain reagents for the amplification of the endogenous control sequence.

## Creating an RQ Plate Document

You can enter sample information into a new plate document, import sample information from existing plate documents, or use a template document to set up new plate documents. This section describes setting up new plate documents. Refer to the Online Help for information about importing sample information or using template documents.

Notes \_\_\_\_\_

To create a new plate document:

1. Select **Start > Programs > Applied Biosystems 7300/7500/7500 Fast > Applied Biosystems 7300/7500/7500 Fast SDS Software** (  ) to start the SDS Software 1.3.1.
2. Select **File > New**.
3. In the Assay drop-down list of the New Document Wizard, select **Relative Quantification (ddCt) Plate**. Accept the default settings for Container and Template (**96-Well Clear** and **Blank Document**).

---

**IMPORTANT!** You cannot use RQ Plate documents for AQ assays and vice versa. You cannot use the RQ Plate to perform relative quantification using the relative standard curve method. The information stored in AQ and RQ Plate documents is not interchangeable.

---

4. Enter a name in the Default Plate Name field, or accept the default.
5. Click **Next >**.

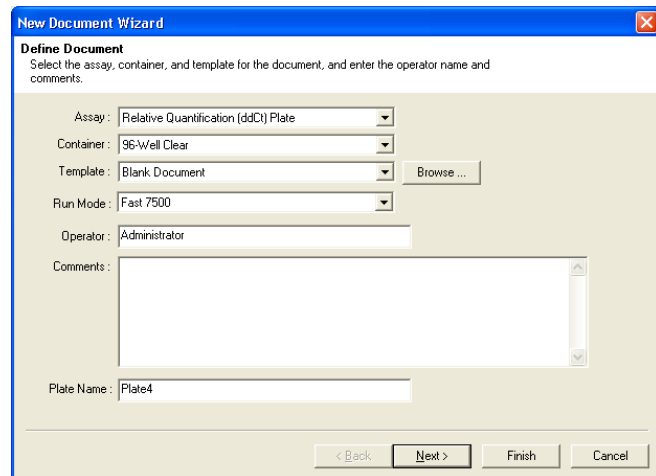

Notes \_\_\_\_\_

\_\_\_\_\_

\_\_\_\_\_



6. Select detectors to add to the plate document.

- a. Click to select a detector. (Ctrl-click to select multiple detectors.) If no detectors are listed in the Detector Manager, click **New Detector** to open the New Detector dialog box. For more information about creating new detectors, refer to [Appendix A, “Creating Detectors.”](#) on page 79.
- b. Click **Add>>**. The detectors are added to the plate document.

**Note:** To remove a detector from the Detectors in Document panel, select the detector, then click **Remove**.

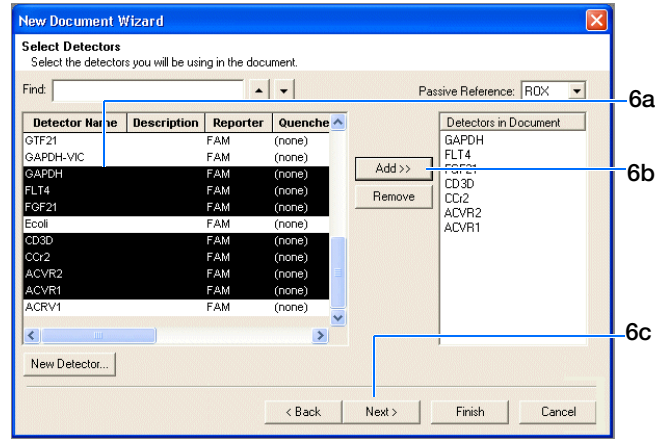

- c. Click **Next >**.

7. Specify the detectors and tasks for each well.

- a. Click a well (or group of wells, for replicates) to select it.
- b. Click to select the detector(s) for the well.
- c. Click under the Task column to assign the detector task.
- d. Select **Use**.
- e. Click **Finish**.

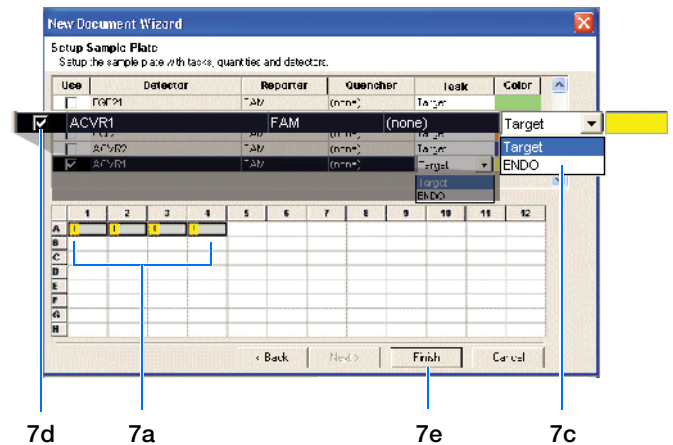

You cannot add RQ plates to RQ studies unless you have specified sample names, as indicated in the message shown to the right. Click **OK**.

The SDS Software 1.3.1 creates the plate document and displays the Well Inspector.

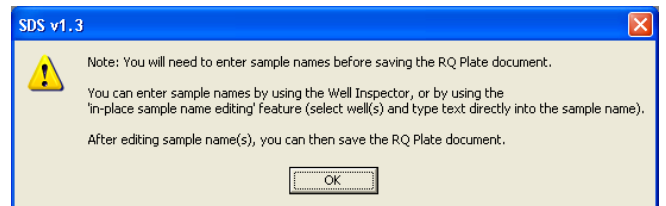

Notes

**8.** Enter the sample names.

- a. In the Well Inspector, click a well or click-drag to select replicate wells.
- b. Enter the sample name.
- c. If necessary, change the setting for the Passive Reference dye. (By default, the ROX™ dye is selected.)
- d. Repeat [steps a through c](#) until you specify sample names and passive reference dyes for all the wells on the plate.

---

**IMPORTANT!** If your experiment does not use all the wells on a plate, do not omit the wells from use at this point. You can omit unused wells after the run. For information about omitting unused wells, refer to the Online Help.

---

**Note:** You can change the sample setup information (sample name, detector, task) after a run is complete, if necessary.

---

- e. Close the Well Inspector.

**9.** Verify the information on each well in the Setup tab.

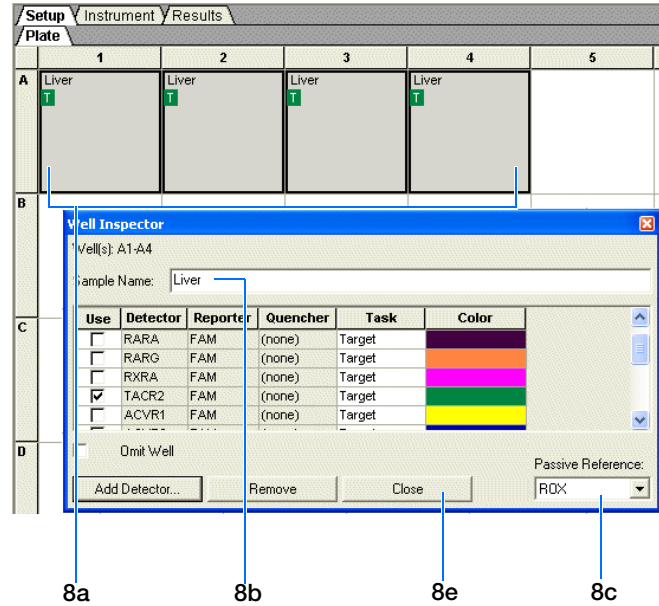

Notes \_\_\_\_\_





## Sample Experiment

In the example RQ experiment, the samples for each of the three tissues (liver, kidney, and bladder) are loaded on three separate plates. Consequently, three RQ Plate documents are created, one for each of the sample plates.

Because the experiment is singleplex, there is only one sample—either a target or endogenous control—in each well. Each well is associated with a detector (indicated by the colored squares). Additionally, each well is assigned a detector task—T (target) or E (endogenous control).

The figure below shows the example RQ Plate document after sample names, detectors, and detector tasks are assigned for each well in the liver plate.

Plate	1	2	3	4	5	6	7	8	9	10	11	12
A	Liver T	Liver T	Liver T	Liver T	Liver T	Liver T	Liver T	Liver T	Liver T	Liver T	Liver T	Liver T
B	Liver T	Liver T	Liver T	Liver T	Liver T	Liver T	Liver T	Liver T	Liver T	Liver T	Liver T	Liver T
C	Liver T	Liver T	Liver T	Liver T	Liver T	Liver T	Liver T	Liver T	Liver T	Liver T	Liver T	Liver T
D	Liver T	Liver T	Liver T	Liver T	Liver T	Liver T	Liver T	Liver T	Liver T	Liver T	Liver T	Liver T
E	Liver T	Liver T	Liver T	Liver T	Liver T	Liver T	Liver T	Liver T	Liver T	Liver T	Liver T	Liver T
F	Liver T	Liver T	Liver T	Liver T	Liver T	Liver T	Liver T	Liver T	Liver T	Liver T	Liver T	Liver T
G	Liver T	Liver T	Liver T	Liver T	Liver T	Liver T	Liver T	Liver T	Liver T	Liver T	Liver T	Liver T
H	Liver T	Liver T	Liver T	Liver T	Liver T	Liver T	Liver T	Liver T	Liver T	Liver T	Liver T	Liver T

Notes

## Specifying Thermal Cycling Conditions and Starting the Run

### Running Assays Using Fast Thermal Cycling Conditions

Run assays using Fast thermal cycling conditions.

- Applied Biosystems has verified the performance of Fast thermal cycling and the TaqMan Fast Universal PCR Master Mix (2X), No AmpErase UNG, for quantitative applications only and not for endpoint applications, such as allelic discrimination (SNP Genotyping or Plus/Minus Assays).
- Applied Biosystems has verified the performance of Applied Biosystems TaqMan Gene Expression Assays and Custom TaqMan<sup>®</sup> Gene Expression Assays using the default Fast thermal cycling conditions and the TaqMan Fast Universal PCR Master Mix (2X), No AmpErase UNG.
- It is expected that the vast majority of custom 5' nuclease quantification assays designed with the Applied Biosystems Assay Design Guidelines will provide comparable performance when run using the default Fast thermal cycling conditions and the TaqMan Fast Universal PCR Maser Mix (2X), No AmpErase UNG (as compared to running the standard thermal cycling conditions and the TaqMan<sup>®</sup> 2X Universal PCR Master Mix). If you encounter poor performance, see “[Troubleshooting](#)” on page 56.
- When performing multiplex applications (when more than one target is amplified in a single tube), it may be necessary to perform some assay reoptimization. Before performing any multiplex applications, see the troubleshooting information on [page 56](#) for further information.

### Expert Mode

Expert mode allows you to select only those filters required for a particular experiment, reducing run times to less than 30 minutes. Observe the following guidelines:

- The default thermal cycling protocol for Fast mode has an extension time of 30 seconds. This extension time has been tested for TaqMan Gene Expression Assays, TaqMan Pre-Developed Assay Reagents and Primer Express software designed assays that are run using default Fast thermal cycling mode conditions.
- Use of extension times below 30 seconds has been shown to affect the performance of some assays. Validate the performance of assays with extension times of less than 30 seconds.
- Applied Biosystems strongly recommends the use of ROX<sup>™</sup> dye to normalize variation caused by pipetting error.
- When using the ROX passive reference feature, it is important to select *both* the FAM<sup>™</sup> and ROX filters.
- Add extension time if you use more than three filters to allow for data collection processes.

---

**Note:** The filters are labeled Filter A through E by default, but may be renamed as desired. Select **Tools > Filter Configuration** to open the Filter Naming window.

---



### Default Thermal Cycling Conditions for PCR

If you selected the two-step RT-PCR method for your RQ experiment (recommended), you have already completed the RT step and are ready to PCR amplify cDNA.

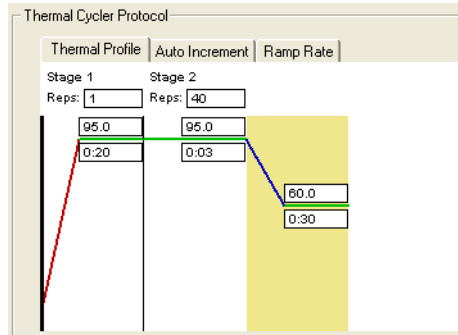

The default thermal cycling conditions for the PCR step of the procedure, shown in the following table, should appear in the Instrument tab.

Fast Default Times and Temperatures (Two-step RT-PCR)				
1) RT Step	HOLD	HOLD	* For reference only. RT is complete at this point.	
	10 min @ 25 °C	120 min @ 37 °C		
Fast Thermal Cycling Conditions (Fast 7500 users only)				
2) PCR Step Fast Conditions	Enzyme Activation		Melt	Anneal/Extend
	95 °C 0.20		3 sec @ 95 °C	30 sec @ 60 °C

Notes \_\_\_\_\_

To specify thermal cycling conditions and start the run:

**1.** Select the **Instrument** tab.

By default, the standard PCR conditions for the PCR step of the two-step RT-PCR method are displayed.

**2.** Verify that:

- For two-step RT-PCR, the default PCR thermal cycling conditions are set.
- Sample volume is 20  $\mu$ L.

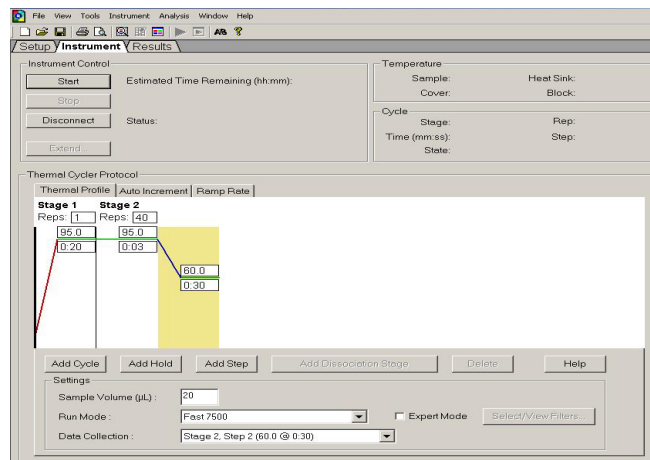

- Fast 7500 is selected as the run mode.

**Note:** If you are using SYBR<sup>®</sup> Green I reagent chemistry and you want to determine if there is contamination or if you want to determine the dissociation temperature, create a separate Dissociation assay or template. Refer to the Online Help for more information. Users of the 7500 Fast System can use SYBR Green I reagents with Standard or 9600 Emulation run modes.

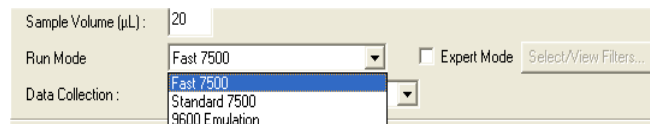

**IMPORTANT!** If you wish to enable Expert Mode continue to [step 3](#). Otherwise skip to [step 7](#).

**3.** Click the Expert Mode checkbox.

**4.** Click the **Select/View Filters** button.

Notes



5. Select filters for data collection. If the checkbox next to a filter is checked, that filter is used for data collection.

---

**Note:** If no filter is selected no data will be collected.

---

---

**Note:** The use of Rox is strongly recommended to normalize variation caused by pipetting error. Both the Fam and Rox filters must be turned on in order to excite the Rox passive reference dye in Applied Biosystems Master Mix correctly.

---



6. Click **OK**.
7. Select **File > Save As**, enter a name for the RQ Plate document, then click **Save**.
8. Load the plate into the precision plate holder in the instrument. Ensure that the plate is properly aligned in the holder.

---

**Note:** The A1 position is in the top-left of the instrument tray. The bar code is toward the front of the instrument.

---

9. Click **Start**.

As the instrument performs the PCR run, it displays real-time status information in the Instrument tab and records the fluorescence emissions.

After the run, a message indicates whether or not the run is successful.

All data generated during the run is saved to the RQ Plate document that you saved in [step 7](#).



Notes

---

---

## Analyzing and Viewing RQ Plate Data

### Starting the Analysis

To analyze RQ Plate data after the run, click or select **Analysis > Analyze**. The SDS Software 1.3.1 mathematically transforms the raw fluorescence data to establish a comparative relationship between the spectral changes in the passive reference dye and those of the reporter dyes. Based on that comparison, the software generates four result views: Plate, Spectra, Component, and Amplification Plot.

### About the Results Tab

In the Results tab, you can view the results of the run and change the parameters. For example, you can omit samples or manually set the baseline and threshold. If you change any parameters, you should reanalyze the data.

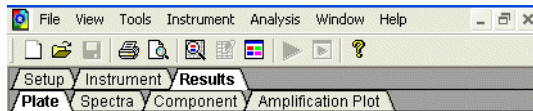

The Results tab has four secondary tabs, each of which is described below. Details are provided in the Online Help.

- To move between views, click a tab.
- To select all 96 wells on a plate, click the upper-left corner of the plate.

	1	2	3	4	5	6
A	Liver T 6.42	Liver T 6.44	Liver T 6.43	Liver T 6.66	Liver T 5.34	Liver T 5.31
B	Liver T 5.87	Liver T 5.93	Liver T 5.95	Liver T 5.97	Liver T 6.52	Liver T 6.28

- To adjust graph settings, double-click the y- or x-axes of a plot to display the Graph Settings dialog. The adjustable settings depend on which plot you are viewing.

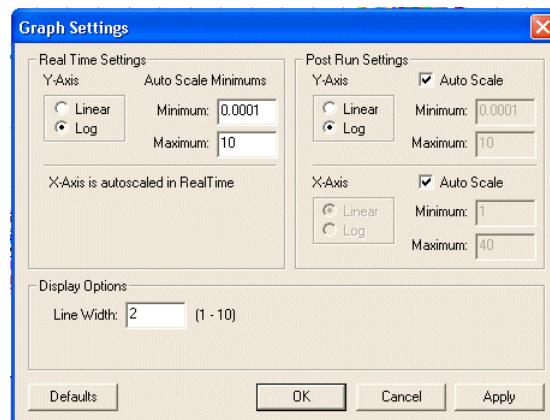

Notes \_\_\_\_\_



**Plate Tab** Displays the results data of each well, including the:

- Sample name and detector task and color for each well
- Calculated  $R_n$  value

Setup Instrument Results										
Plate Spectra Component Amplification Plot										
	1	2	3	4	5	6	7	8	9	10
<b>A</b>	Liver T 6.42	Liver T 6.44	Liver T 6.43	Liver T 6.66	Liver T 5.34	Liver T 5.31	Liver T 5.23	Liver T 5.10	Liver T 7.83	Liver T 7.76
<b>B</b>	Liver T 5.87	Liver T 5.93	Liver T 5.95	Liver T 5.97	Liver T 6.52	Liver T 6.28	Liver T 6.36	Liver T 6.72	Liver T 2.46	Liver T 2.59
<b>C</b>	Liver T 6.81	Liver T 6.83	Liver T 6.91	Liver T 6.71	Liver T 4.68	Liver T 4.84	Liver T 4.70	Liver T 4.76	Liver T 6.38	Liver T 6.18
<b>D</b>	Liver T 5.94	Liver T 6.09	Liver T 6.18	Liver T 6.22	Liver T 7.01	Liver T 6.94	Liver T 6.97	Liver T 7.00	Liver T 6.85	Liver T 6.79
<b>E</b>	Liver T 6.75	Liver T 6.96	Liver T 7.10	Liver T 7.31	Liver T 5.18	Liver T 5.15	Liver T 5.10	Liver T 5.14	Liver T 5.17	Liver T 5.18

**Spectra Tab** Displays the fluorescence spectra of selected wells.

- The Cycles slider allows you to see the spectra for each cycle by dragging it with the pointer.
- The Cycle # text box shows the current position of the slider.

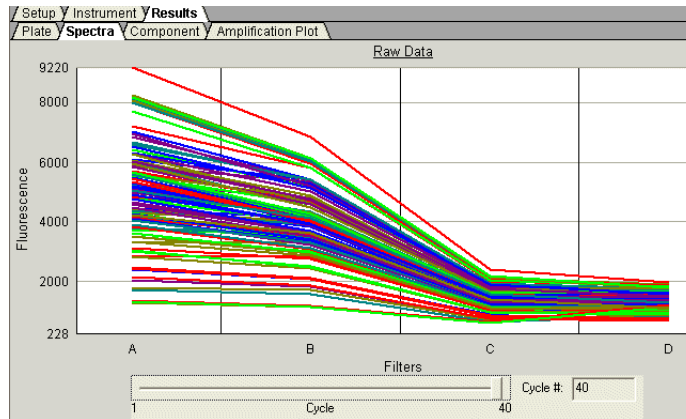

**Component Tab** Displays the complete spectral contribution of each dye in a selected well over the duration of the PCR run. Only the first selected well is shown at one time.

Notes

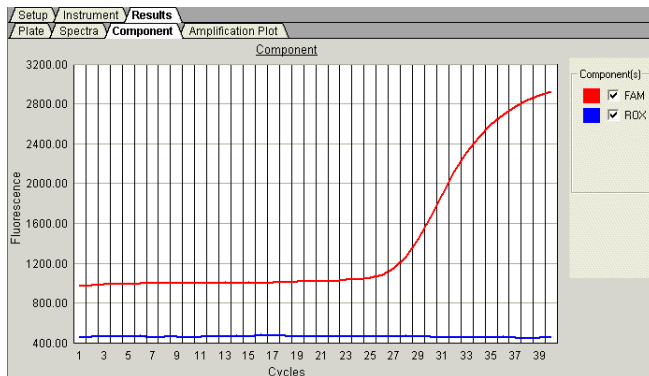

**Note:** If you are using TaqMan<sup>®</sup> products, three components (ROX<sup>™</sup> dye, reporter dye, and TAMRA<sup>™</sup> quencher) are displayed in the Component tab. If you are using TaqMan<sup>®</sup> MGB products, only two components (ROX and reporter dyes) are displayed, as shown in the figure on the right.

### Amplification Plot Tab

Displays a plot of  $R_n$  as a function of cycle number for the selected detector and well(s).

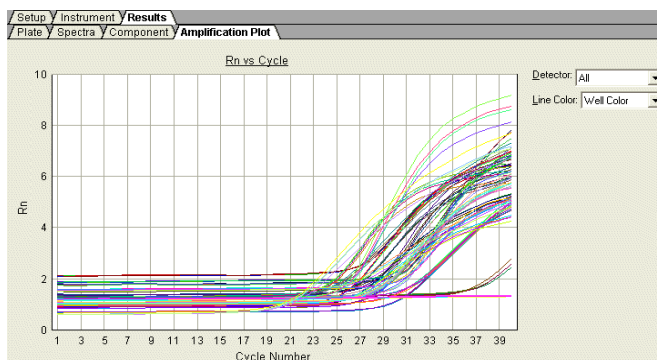

### Reanalyzing Data

Raw fluorescence data (spectra),  $R_n$  values, and well information (sample name, detector, and detector task) are saved in an RQ plate document.

If you decide to omit wells or change well information after a run is complete, you must reanalyze the data.

**Note:** After the software analyzes data, the Analyze button is disabled (▶). Whenever you change a setting that requires reanalysis, the Analyze button is enabled (▶).

### Notes





## Exporting RQ Plate Data

You can export numeric data from RQ plates into text files, which can then be imported into spreadsheet applications such as Microsoft Excel.

1. Select **File > Export**, then select the data type to export:
  - **Sample Setup** (\*.txt)
  - **Calibration Data** (\*.csv)
  - **Background Spectra** (\*.csv)
  - **Component** (\*.csv)
  - **Rn** (\*.csv)

Typically, you export sample setup data for newly created and newly run plates; other data types are exported for existing plates.

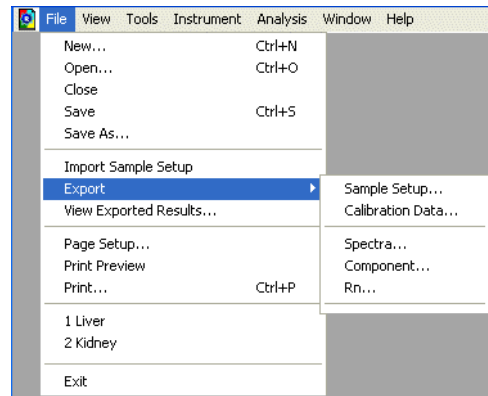

2. Enter a file name for the export file.

**Note:** The name of the dialog box depends on the type of data you want to export.

3. Click **Save**.

Notes \_\_\_\_\_

\_\_\_\_\_

\_\_\_\_\_

## Troubleshooting

Troubleshooting		
Observation	Possible Cause	Action
High $C_T$ values/poor precision or failed PCR reactions	Target is difficult to amplify	<ul style="list-style-type: none"> <li>Increase the annealing/extension time in the thermal cycler protocol.</li> <li>Increase the annealing/extension temperature to 62 °C.</li> </ul>
	Insufficient cDNA template is present	Use 10 to 100 ng of cDNA template per 20- $\mu$ L reaction.
	Quality of cDNA template is poor	<ol style="list-style-type: none"> <li>Quantify the amount of cDNA template.</li> <li>Test the cDNA template for the presence of PCR inhibitors.</li> </ol>
	Sample degradation	Prepare fresh cDNA, then repeat the experiment.
	The TaqMan 2X Universal PCR Master Mix was used instead of the TaqMan Fast Universal PCR Master Mix (2X), No AmpErase UNG	Prepare the reactions with the correct Master Mix.
	Primer-dimer formation	To ensure optimal results, run the reaction plate as soon as possible after completing the reaction setup. If you cannot run a reaction plate within 2 hours after completing the reaction setup, refrigerate or freeze the reaction plate until you can load and run it on the 7500 Fast instrument.
Low $\Delta R_n$ or $R_n$ values	Extension time is too short	Use the default thermal profile settings (see <a href="#">page 49</a> ).
	Primer-dimer formation	To ensure optimal results, run the reaction plate as soon as possible after completing the reaction setup. If you cannot run a reaction plate within 2 hours after completing the reaction setup, refrigerate or freeze the reaction plate until you can load and run it on the 7500 Fast instrument.
Run takes more than 40 minutes	Thermal cycler mode is set to Standard or 9600 Emulation	Make sure that the thermal cycler mode is set to Fast (see <a href="#">page 50</a> ).
$R_n$ vs. Cycle plot is not displayed	ROX dye was not selected as the passive reference when the plate document was set up	Select ROX dye as the passive reference when you set up the plate document.
Extremely high $\Delta R_n$ or $R_n$ values	ROX dye was not selected as the passive reference when the plate document was set up	Select ROX dye as the passive reference when you set up the plate document.
	Evaporation	Make sure that the reaction plate is sealed completely, especially around the edges.

### Notes



Troubleshooting		
Observation	Possible Cause	Action
High variability across the reaction plate	ROX dye was not selected as the passive reference when the plate document was set up	Select ROX dye as the passive reference when you set up the plate document.
	Evaporation	Make sure that the reaction plate is sealed completely, especially around the edges. Use reagents that contain ROX passive reference dye.
High variability across replicates	Reaction mix was not mixed well	Mix the reaction mix gently by inversion, then centrifuge briefly before aliquoting to the reaction plate.

### Troubleshooting Multiplex Applications

**IMPORTANT!** Due to the challenging nature of multiplex applications and the complexity that can be encountered, it is impossible to guarantee assay performance. However, the recommendations listed below should be helpful when running multiplex applications using Fast thermal cycling conditions and the TaqMan Fast Universal PCR Master Mix (2X), No AmpErase UNG.

Perform the recommendations in the order listed.

When running multiplex applications:

1. Increase the annealing/extension temperature to 62 °C.
2. If you do not obtain the expected performance by increasing the annealing/extension temperature to 62 °C, increase the annealing/extension time in the thermal cycling protocol by 5 seconds, to 35 seconds.
3. If you do not obtain acceptable performance by increasing both the annealing/extension temperature and time, assay reoptimization may be required. Refer to the *Real-Time PCR Systems Chemistry Guide* (PN 4378658) for more information.

Notes \_\_\_\_\_



## Chapter 5 Generating Data from RQ Plates – 7500 Fast System

*Troubleshooting*

Notes \_\_\_\_\_



# Analyzing Data in an RQ Study

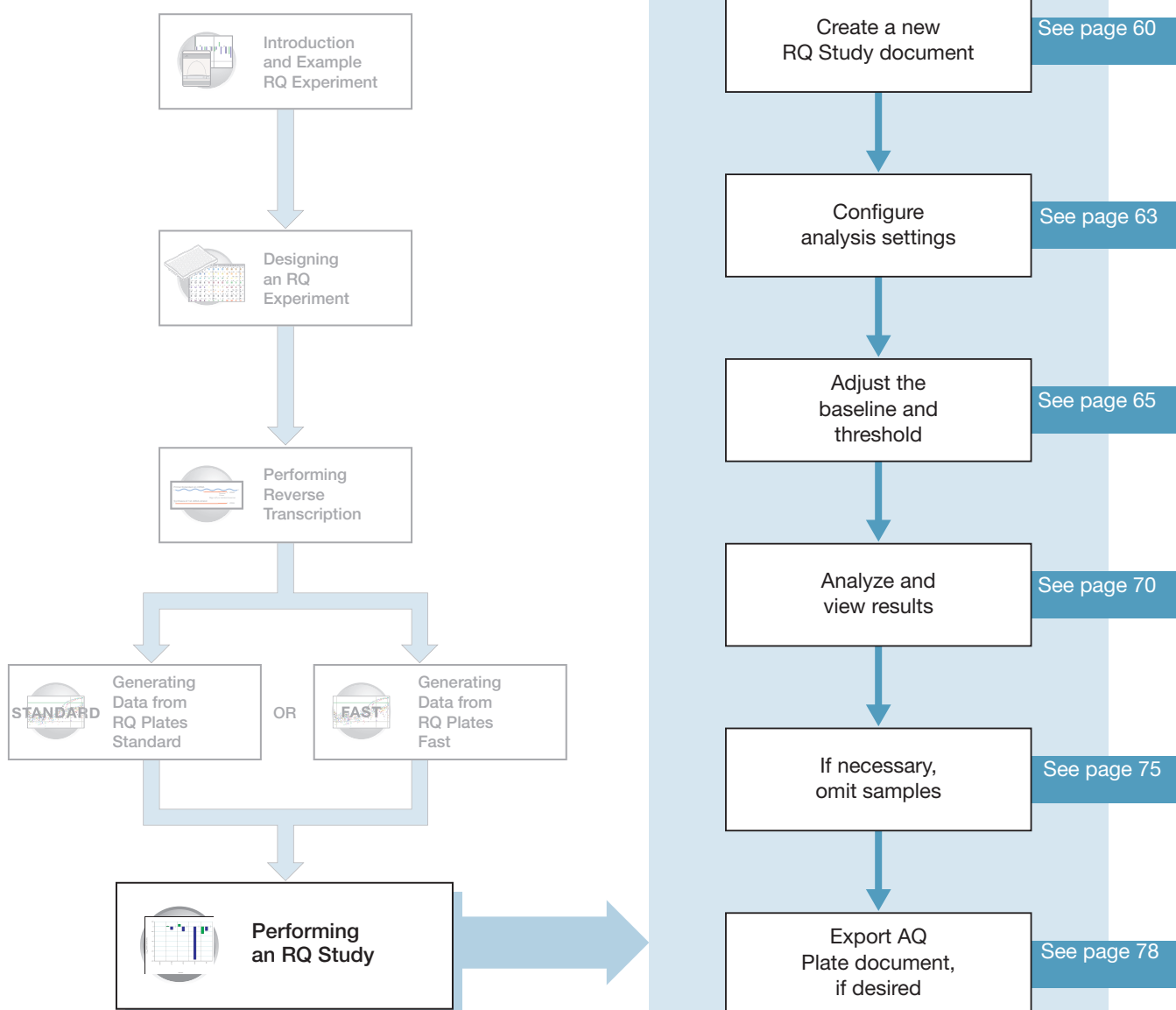

Notes \_\_\_\_\_

\_\_\_\_\_

\_\_\_\_\_

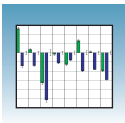

## Creating an RQ Study Document

To conduct a comparative analysis of RQ plates in a study or to analyze a single RQ plate experiment, you must first create an RQ Study document.

---

**IMPORTANT!** RQ Study software is an optional package for the 7300 instrument, but it is standard for the 7500 and 7500 Fast instruments.

---

---

**IMPORTANT!** RQ plates may be run with either standard or Fast thermal cycling conditions. An RQ study must be composed of RQ plates of the same thermal cycling protocol. RQ plates run on standard thermal cycling protocols and RQ plates run on Fast thermal cycling protocols cannot be combined into a single RQ study.

---

The SDS Software 1.3.1 uses the comparative Ct method ( $2^{-\Delta\Delta C_t}$ ) of relative quantification. For more information about methods of calculating relative quantification, refer to *ABI PRISM® 7700 Sequence Detection System User Bulletin #2* (PN 4303859).

In an RQ study, you can...	You cannot...
<ul style="list-style-type: none"><li>• Select the endogenous control and the calibrator sample.</li><li>• Select the control type when applicable.</li><li>• Set baseline and threshold values and RQ Min/Max Confidence Levels.</li><li>• Omit individual wells or sample replicates.</li></ul>	<ul style="list-style-type: none"><li>• Create, add, or modify samples.</li><li>• Create, add, or modify detectors.</li><li>• Change detector tasks.</li></ul> <p>(You can perform these operations in RQ Plate documents.)</p>

Notes \_\_\_\_\_

\_\_\_\_\_

\_\_\_\_\_

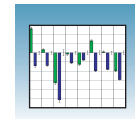

To create a new RQ Study document:

1. Select **File> New**.
2. In the Assay drop-down list of the New Document Wizard, select **Relative Quantification (ddCt) Study**. Accept the default settings for Container and Template (**96-Well Clear** and **Blank Document**).
3. Enter a name in the Default Plate Name field, or accept the default.
4. Click **Next>**.

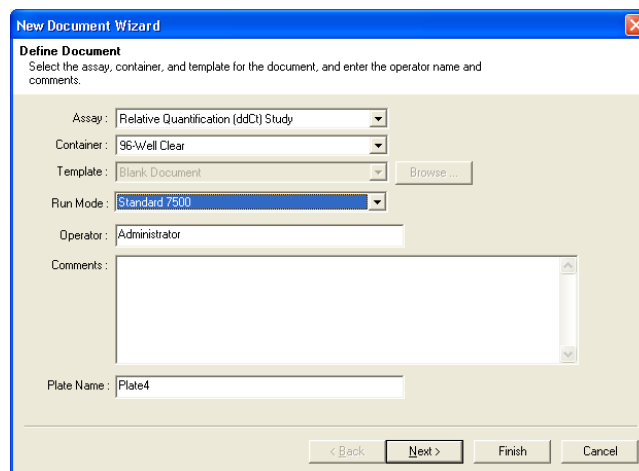

5. Add RQ plates to the study.

- a. Click **Add Plates**.

**Note:** You can add up to 10 RQ plates to an RQ study.

- b. Select the plate(s) that you want to add to the study, then click **Open**.

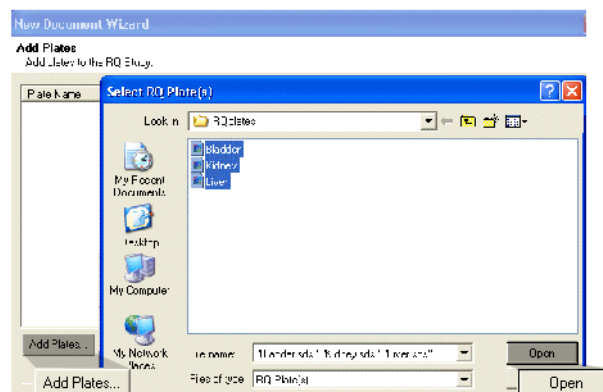

The selected plates are displayed.

**IMPORTANT!** All plates added to a study must have identical thermal cycling parameters—the same number of steps, cycles, sample volume, emulation mode. The SDS Software 1.3.1 will reject a plate if it detects any differences. (The first plate added to the study serves as the reference plate against which other plates are compared.)

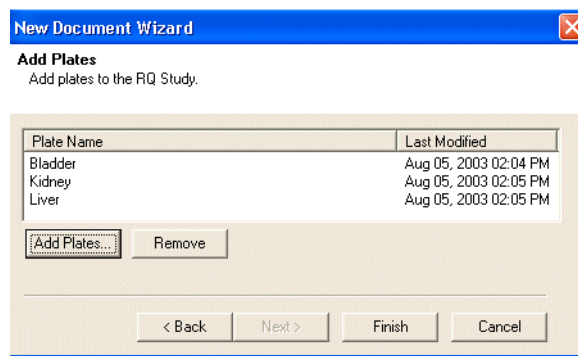

Notes

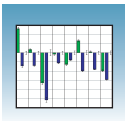

6. Click **Finish**. If desired, save the RQ Study document when prompted.

The SDS Software 1.3.1 opens a new RQ Study document and displays the RQ Study main view with its three panes:

- a. **RQ Detector grid** – Allows you to select detectors to associate with the loaded study. For each detector, Color, Detector name, Threshold value, Auto Ct, and Baseline are displayed.

---

**Note:** At this point, all the values in the Threshold, Auto Ct, and Baseline columns are set to the default values (0.200000, Manual, and [6,15], respectively).

---

- b. **RQ Sample grid** – Displays the samples associated with the selected detector(s). The Sample Grid displays numerical results of RQ calculations and has two subtabs: Sample Summary and Well Information.
- c. **RQ Results panel** – Contains the three results-based tabs: Plate (default), Amplification Plot, and Gene Expression.

---

**Note:** You can save the RQ Study document now, or wait until after specifying analysis settings and analyzing the data.

---

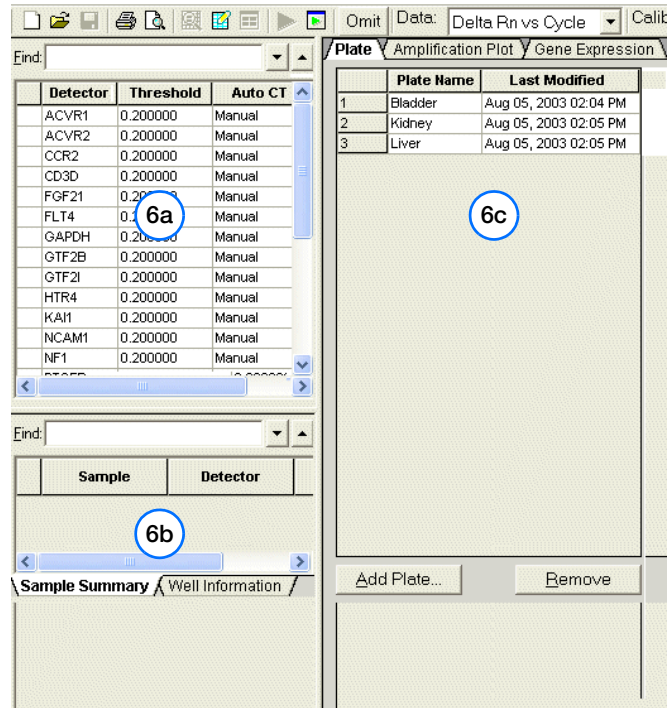

Notes \_\_\_\_\_



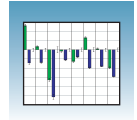

## Configuring Analysis Settings

After you create the RQ Study document, you must specify parameter values for the analysis.

Unless you have already determined the optimal baseline and threshold settings for your experiment, use the automatic baseline and threshold feature of the SDS Software 1.3.1 (auto Ct), explained below. If the baseline and threshold were called correctly for each well, you can proceed to view the results. Otherwise, you must manually set the baseline and threshold as explained in [“Manual Baseline and Threshold Determination”](#) on page 65.

To configure analysis settings:

1. Click  or select **Analysis > Analysis Settings**.
2. In the Detector drop-down list, select **All**.
3. Select **Auto Ct**. The SDS Software 1.3.1 automatically generates baseline and threshold values for each well.

---

**IMPORTANT!** After analysis, you must verify that the baseline and threshold were called correctly for each well, as explained in [“Adjusting the Baseline and Threshold”](#) on page 65.

---

Alternatively, you can select Manual Ct and specify the threshold and baseline manually.

4. Select the Calibrator Sample.

---

**Note:** If your experiment uses only a single plate, there must be at least two different samples that have different names and have their own endogenous controls. (You can go back to a saved RQ Plate document and change the sample names, if necessary.)

---

5. Select the Endogenous Control Detector.

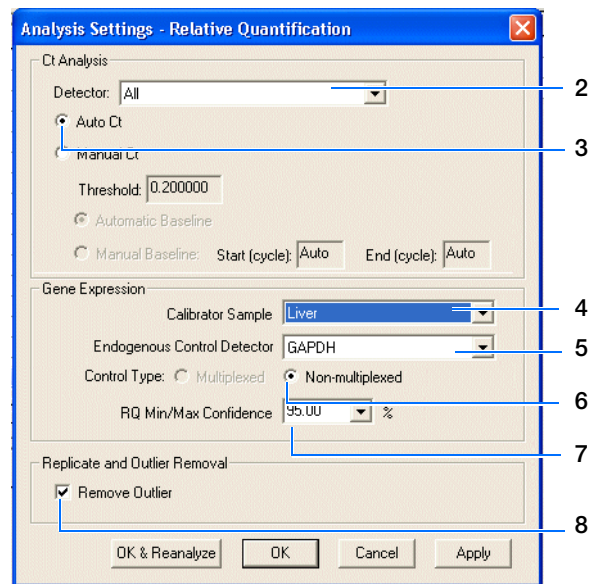

### Notes

---



---



---

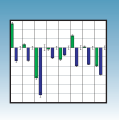

6. Select the Control Type if the study contains both multiplex and nonmultiplex reactions.

**Note:** The Multiplexed or Non-Multiplexed options are active only if the plates loaded for analysis contain both multiplexed and nonmultiplexed reactions that share the same endogenous control.

7. Select the RQ Min/Max Confidence level.

**Note:** The SDS Software 1.3.1 uses this value to calculate error bars for gene expression levels, as explained in “Error Bars for Gene Expression Plots” on page 73.

8. Optionally, select **Remove Outliers** to enable the SDS Software 1.3.1 to automatically identify and filter outliers for groups containing at least four replicates.

**Note:** You can also remove outliers manually, as explained in “Omitting Samples from a Study” on page 75.

9. Click **OK & Reanalyze**. The detector information appears in the RQ Detector grid.

After analysis, the Threshold column displays the automatically calculated threshold values. The Auto Ct and Baseline columns are set to “Auto.”

For more information about the settings in the Analysis Settings dialog box, refer to the Online Help.

After the analysis, verify that the baseline and threshold were called correctly for each detector, as explained in the following section.

The screenshot shows two windows from the SDS software. The top window is the 'RQ Detector' grid, which lists various detectors with their corresponding threshold, auto CT, and baseline values. The bottom window is the 'Plate' list, showing three plates: Bladder, Kidney, and Liver, with their last modified dates.

Detector	Threshold	Auto CT	Baseline
ACVR1	0.535276	Auto	Auto
ACVR2	0.353770	Auto	Auto
CCR2	0.056001	Auto	Auto
CD3D	0.267214	Auto	Auto
FGF21	0.200000	Auto	Auto
FLT4	0.451420	Auto	Auto
GAPDH	0.418936	Auto	Auto
GTF2B	0.251278	Auto	Auto
GTF2I	0.280024	Auto	Auto
HTR4	0.082686	Auto	Auto
KAI1	0.323054	Auto	Auto
NCAM1	0.236747	Auto	Auto
NF1	0.158621	Auto	Auto
PTGFR	0.301821	Auto	Auto

Plate Name	Last Modified
1 Bladder	Aug 05, 2003 02
2 Kidney	Aug 05, 2003 02
3 Liver	Aug 05, 2003 02

Notes

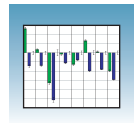

## Adjusting the Baseline and Threshold

### Automatic Baseline and Threshold Determination

The SDS Software 1.3.1 calculates baseline and threshold values for a detector based on the assumption that the data exhibit the “typical” amplification curve.

A typical amplification curve has a:

- Plateau phase (a)
- Linear phase (b)
- Exponential (geometric phase) (c)
- Background (d)
- Baseline (e)

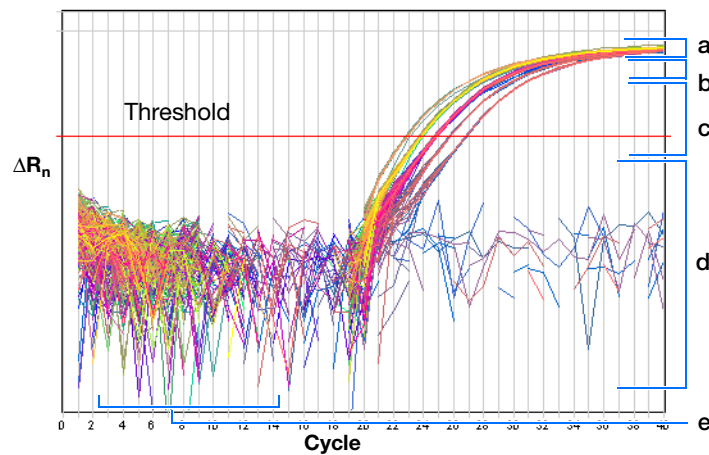

Experimental error (such as contamination, pipetting errors, and so on) can produce data that deviate significantly from data for typical amplification curves. Such atypical data cause the software algorithm to generate incorrect baseline and threshold values for the associated detector. Therefore, Applied Biosystems recommends reviewing all baseline and threshold values after analysis of the study data. If necessary, adjust the values manually as described on [page 68](#).

### Manual Baseline and Threshold Determination

If you set the baseline and threshold values manually for any detector in the study, you must perform the adjustment procedure on [page 68](#) for each of the detectors.

The following amplification plots show the effects of baseline and threshold settings.

Notes \_\_\_\_\_

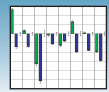

**Baseline Set Correctly**

The amplification curve begins after the maximum baseline. No adjustment necessary.

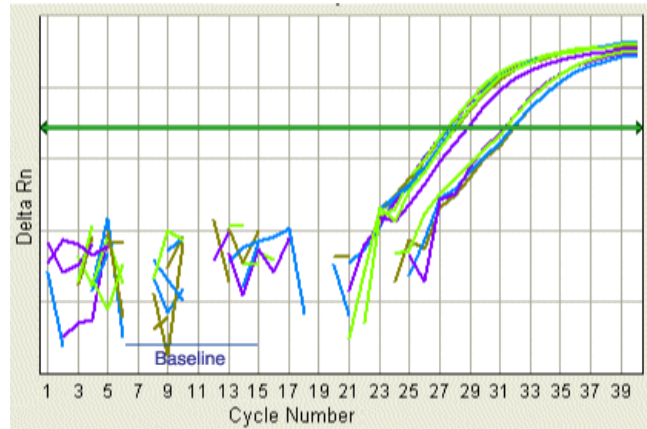

**Baseline Set Too Low**

The amplification curve begins too far to the right of the maximum baseline. Increase the End Cycle value.

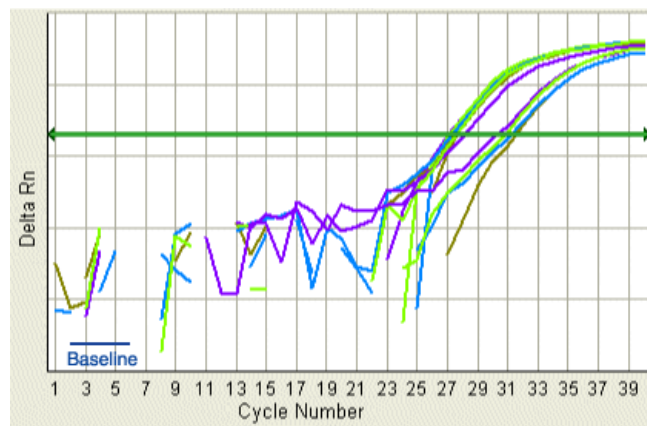

**Baseline Set Too High**

The amplification curve begins before the maximum baseline. Decrease the End Cycle value.

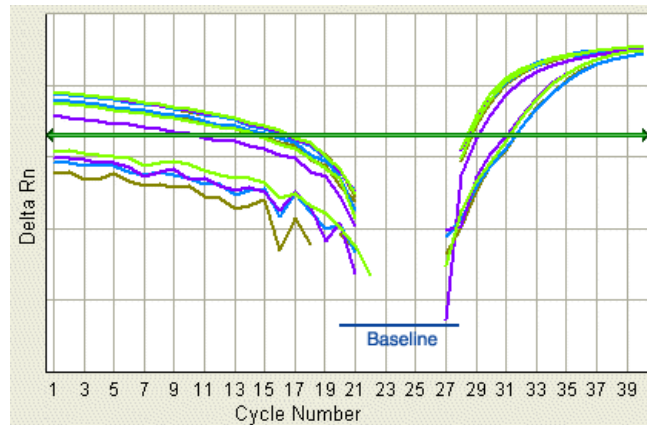

Notes \_\_\_\_\_

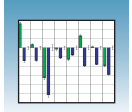

### Threshold Set Correctly

The threshold is set in the exponential phase of the amplification curve.

Threshold settings above or below the optimum increase the standard error of the replicate groups.

Sample	Detector	Task	Avg Ct	Avg dCt	dCt std err	ddCt	RQ	P Value	RQ Min	RQ Max	Out Rerr
Liver	CD3D	Target	27.492	6.369	0.111	0.000	1.000	1.000	0.828	1.208	0
Kidney	CD3D	Target	28.203	8.377	0.207	2.008	0.249	0.002	0.175	0.353	0
Bladder	CD3D	Target	31.585	10.216	0.193	3.847	0.070	0.002	0.050	0.096	0

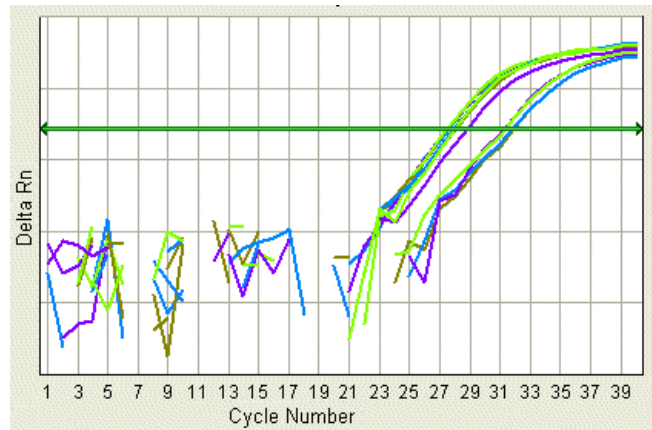

### Threshold Set Too Low

The threshold is set below the exponential phase of the amplification curve. The standard error is significantly higher than that for a plot where the threshold is set correctly. Drag the threshold bar up into the exponential phase of the curve.

Sample	Detector	Task	Avg Ct	Avg dCt	dCt std err	ddCt	RQ	P Value	RQ Min	RQ Max	Out Rerr
Liver	CD3D	Target	21.117	-0.006	0.246	0.000	1.000	1.000	0.659	1.517	0
Kidney	CD3D	Target	21.514	1.688	0.264	1.694	0.309	0.002	0.198	0.483	0
Bladder	CD3D	Target	24.043	2.673	0.281	2.679	0.156	0.002	0.097	0.252	0

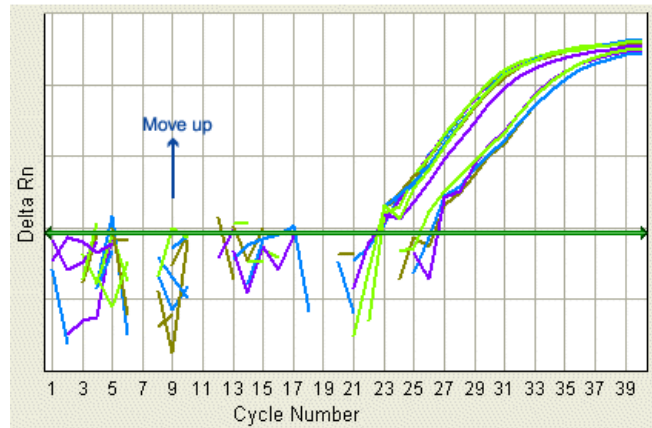

### Threshold Set Too High

The threshold is set above the exponential phase of the amplification curve. The standard error is significantly higher than that for a plot where the threshold is set correctly. Drag the threshold bar down into the exponential phase of the curve.

Sample	Detector	Task	Avg Ct	Avg dCt	dCt std err	ddCt	RQ	P Value	RQ Min	RQ Max	Out Rerr
Liver	CD3D	Target	33.449	12.327	0.114	0.000	1.000	1.000	0.824	1.214	0
Kidney	CD3D	Target	34.493	14.667	0.449	2.340	0.197	0.002	0.092	0.423	0
Bladder	CD3D	Target	38.314	16.944	0.377	4.617	0.041	0.002	0.021	0.077	0

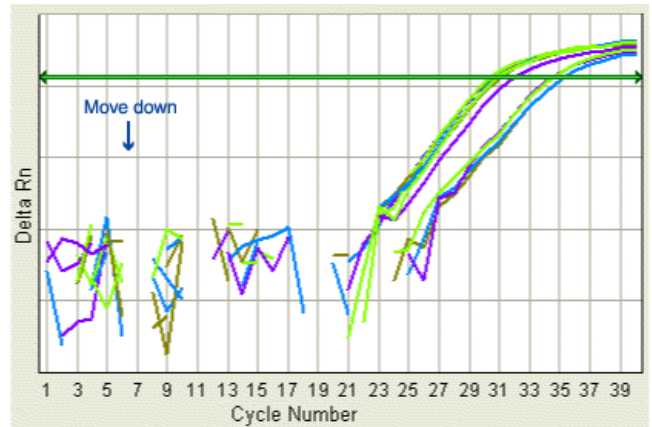

Notes

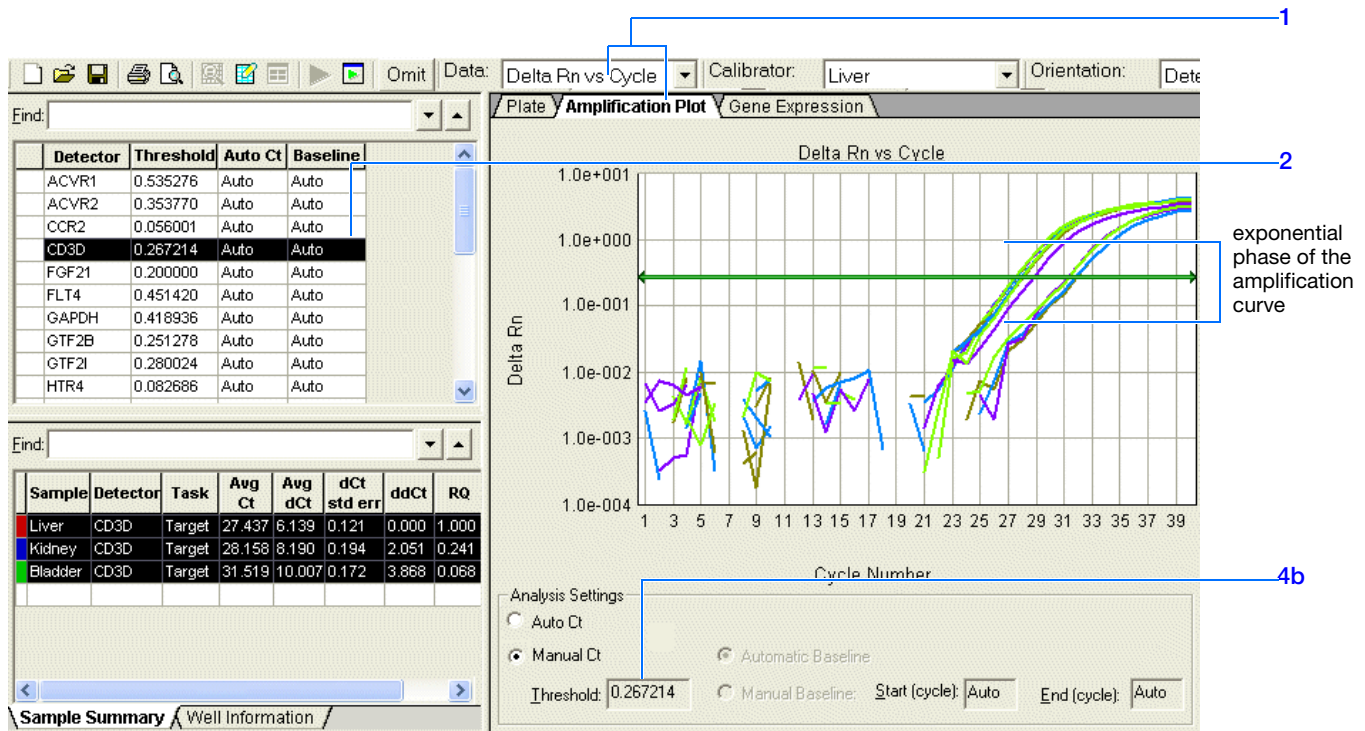
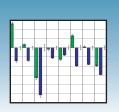

To manually adjust the baseline and threshold:

1. Select the **Amplification Plot** tab, then select **Delta Rn vs. Cycle** in the Data drop-down list.
2. In the RQ Detector grid, select a detector.

The SDS Software 1.3.1 displays the:

- Associated samples (from all plates included in the study) in the RQ Sample grid.
- Graph for the selected detector in the RQ Results panel.

**Note:** When manually adjusting baseline and threshold settings, you can select only one detector at a time. If you select multiple detectors, the Analysis Settings section and the threshold bar are disabled.

## Notes

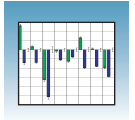

3. Set the baseline for the detector.
  - a. Under Analysis Settings, select **Manual Baseline**.
  - b. Enter values in the Start Cycle and End Cycle fields, ensuring that the amplification curve growth begins at a cycle after the End Cycle value.

---

**Note:** After you change a baseline or threshold setting for a detector, the Analyze button (▶) is enabled, indicating that you must reanalyze the data.

---

4. Set the threshold for the detector.
  - a. Under Analysis Settings, select **Manual Ct**.
  - b. Drag the threshold setting bar so the threshold is:
    - Above the background
    - Below the plateaued and linear regions of the amplification curve
    - Within the exponential phase of the amplification curve

The SDS Software 1.3.1 adjusts the threshold value and displays it in the Threshold field after reanalyzing.

5. Repeat [steps 2 through 4](#) to set the baseline and threshold values for all remaining detectors in the study.

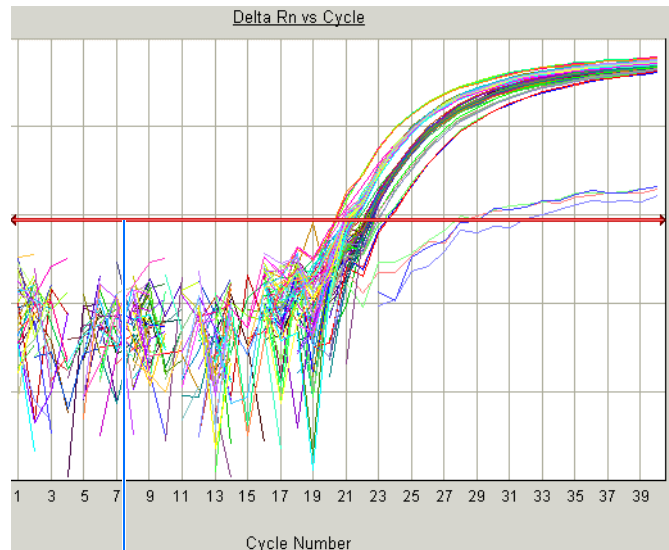

Click and drag the Threshold setting to adjust the threshold. The bar turns red, indicating that the threshold has been changed.

6. Click ▶ or select **Analysis > Analyze** to reanalyze the data using the adjusted baseline and threshold values.

Notes \_\_\_\_\_

\_\_\_\_\_

\_\_\_\_\_

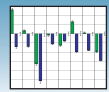

## Analyzing and Viewing the Results of the RQ Study

### Selecting Detectors to Include in Results Graphs

In the RQ Detector Grid, select detectors to include in the result graphs by clicking a detector. (Ctrl-click to include multiple detectors; Click-drag to include multiple adjacent detectors.)

The corresponding samples appear in the RQ Sample Grid. Depending on which tab you select in the RQ Results Panel (Plate, Amplification Plot, or Gene Expression), analysis results are displayed.

To see information about a specific well, select the **Well Information** tab.

### Sample Experiment

Suppose that you want to view the comparative gene expression levels of the following genes when the liver tissue is used as the calibrator: ACVR1, ACVR2, CCR2, CD3D, and FLT4. Selecting the detectors in the RQ Detector grid (1) displays the sample information in the RQ Sample grid (2) and in a result graph in the RQ Results panel (3). Note that:

- The Gene Expression tab is selected, and the gene expression levels are sorted by detector.
- Gene expression levels for bladder samples are indicated by the green bar; those for kidney samples by the blue bar. These colors also indicate the samples in the RQ Sample Grid and the RQ Results Panel plots.
- Because liver samples are used as calibrators, the expression levels are set to 1. But because the gene expression levels were plotted as  $\log_{10}$  values (and the  $\log_{10}$  of 1 is 0), the expression level of the calibrator samples appear as 0 in the graph.
- Because the relative quantities of the targets are normalized against the relative quantities of the endogenous control, the expression level of the endogenous control is 0; there are no bars for GAPDH.
- Fold-expression changes are calculated using the equation  $2^{-\Delta\Delta CT}$ .

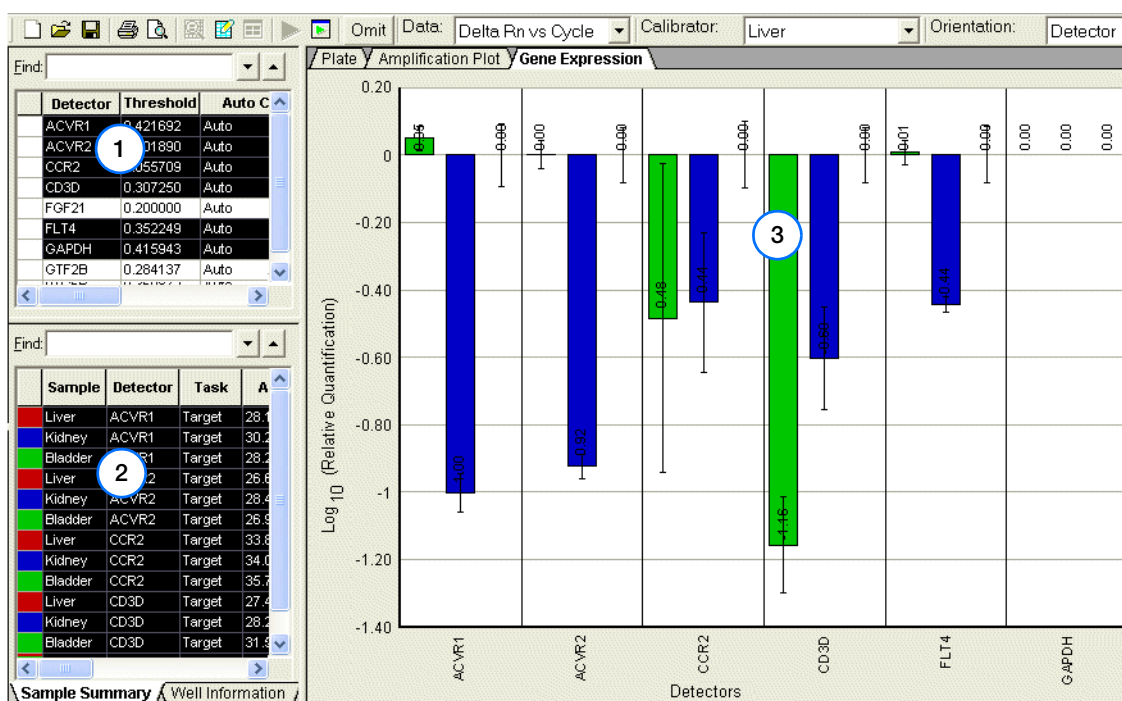

### Notes





**Amplification Plot** The three Amplification Plots allow you to view post-run amplification of specific samples. The Amplification Plots display all samples for selected detectors.

You can adjust graph settings by double-clicking the y- or x-axes of a plot to display the Graph Settings dialog, as shown on [page 33](#).

<p><b>Rn vs. Cycle (Linear) View</b></p> <p>Displays normalized reporter dye fluorescence (<math>R_n</math>) as a function of cycle. You can use this plot to identify and examine irregular amplification.</p> <p>For more information about <math>R_n</math>, refer to the <i>Real-Time PCR Systems Chemistry Guide</i>.</p>	
<p><b><math>\Delta R_n</math> vs. Cycle (Log) View</b></p> <p>Displays dye fluorescence (<math>\Delta R_n</math>) as a function of cycle number. You can use this plot to identify and examine irregular amplification and to manually set the threshold and baseline parameters for the run.</p>	
<p><b>Ct vs. Well Position View</b></p> <p>Displays threshold cycle (<math>C_T</math>) as a function of well position. You can use this plot to locate outliers from detector data sets (see “<a href="#">Omitting Samples from a Study</a>” on <a href="#">page 75</a> for more information).</p> <hr/> <p><b>Note:</b> If there is a data point at <math>C_t0</math>, this point is undetermined, the data point is not actually <math>C_t = 0</math>.</p>	

Notes \_\_\_\_\_

\_\_\_\_\_

\_\_\_\_\_

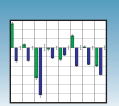

**Gene Expression Plot** Gene Expression plots show the expression level or fold-difference of the target sample relative to the calibrator.

Because the calibrator is compared to itself, the expression level for the calibrator is always 1. Because liver samples are used as calibrators, the expression levels are set to 1. But because the gene expression levels were plotted as  $\log_{10}$  values (and the  $\log_{10}$  of 1 is 0), the expression level of the calibrator samples appear as 0 in the graph.

### Adjusting Graph Settings

You can adjust graph settings for gene expression plots in the Graph Settings dialog box, including:

- Bar width
- 3D bars
- Autoscaling
- Data display as  $\log_{10}$  RQ or Raw RQ

To access the Graph Settings, double-click on one of the axes.

Refer to the Online Help for more information about adjusting graph settings for gene expression plots.

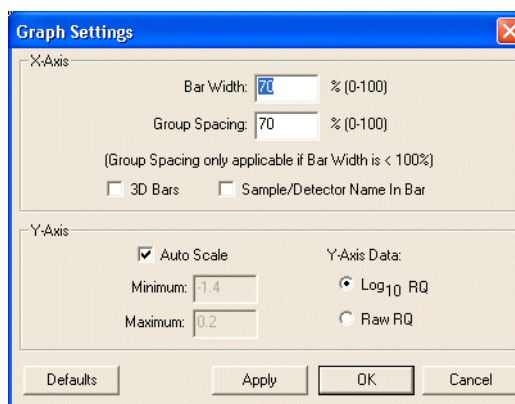

### Gene Expression Plot Orientation: Detector

Detectors are plotted on the x-axis, and each bar shows the detector value of a single sample.

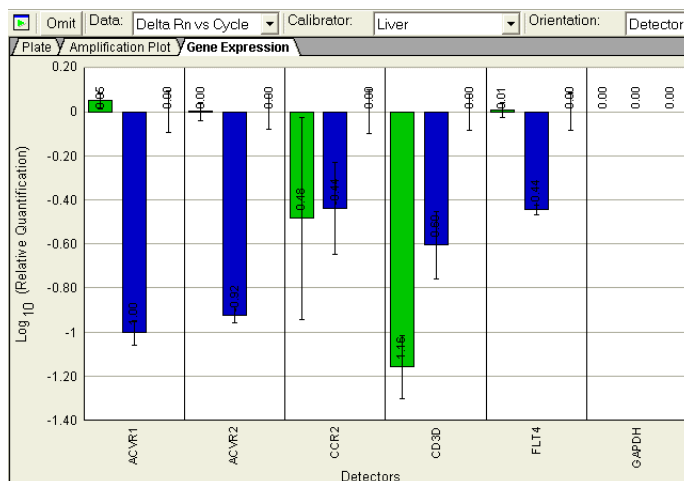

Notes



### Gene Expression Plot Orientation: Sample

Samples are plotted on the x-axis, and each bar shows the set of sample values of a single detector.

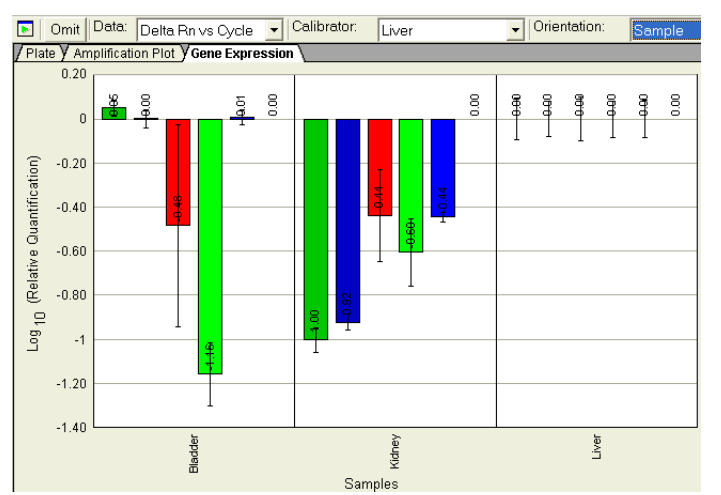

### Error Bars for Gene Expression Plots

The SDS Software 1.3.1 displays error bars for each column in the plot, provided that the associated expression level was calculated from a group of two or more replicates. The error bars display the calculated maximum (RQMax) and minimum (RQMin) expression levels that represent standard error of the mean expression level (RQ value). Collectively, the upper and lower limits define the region of expression within which the true expression level value is likely to occur.

The SDS Software 1.3.1 calculates the error bars based on the RQMin/Max Confidence Level in the Analysis Settings dialog box (see [page 63](#)).

Notes \_\_\_\_\_

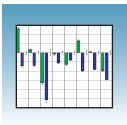

## Reanalyzing an RQ Study

If you change any of the analysis settings, you must reanalyze the data before you can view results. (You can switch between the variations of the Amplification and Gene Expression plots without having to reanalyze the data.)

Suppose you select Liver as the calibrator, then perform an analysis. Next, you view the Amplification and Gene Expression plots. If you then want to use Kidney or Bladder as the calibrator, you need to reanalyze the data before viewing results.

Similarly, if you want to change the baseline or threshold values, the endogenous control, the control type, or the RQ Min/Max parameters, you need to reanalyze your data.

Calibrator	Gene Expression Plot
Liver	
Kidney	
Bladder	

Notes \_\_\_\_\_

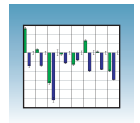

## Omitting Samples from a Study

Experimental error may cause some wells to amplify insufficiently or not at all. These wells typically produce  $C_T$  values that differ significantly from the average for the associated replicate wells. If included in the calculations, these outlying wells (outliers) can result in erroneous measurements.

To ensure precise relative quantification, you must carefully view replicate groups for outliers. You can remove outliers manually using the  $C_T$  vs. Well Position Amplification Plot.

To remove samples from an RQ Study:

1. Select the **Amplification Plot** tab.
2. In the Data drop-down list, select **Ct vs. Well Position**.
3. In the RQ Detector grid, select a detector to examine. All samples that use this detector are displayed in the RQ Samples grid.
4. In the RQ Samples grid, click to select the samples to display in the Amplification Plot.

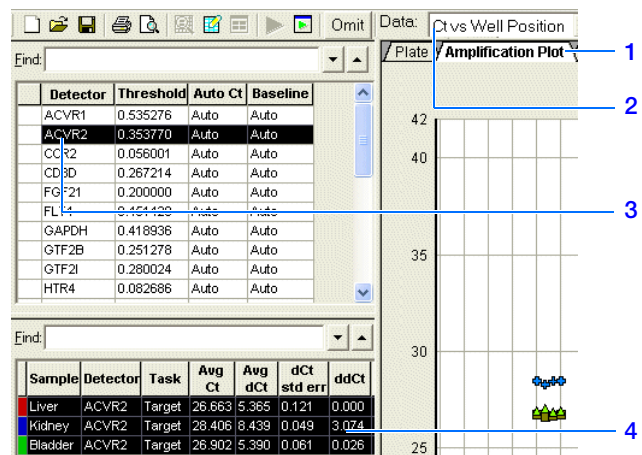

Notes \_\_\_\_\_

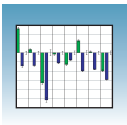

5. Verify the uniformity of each replicate population by comparing the groupings of  $C_T$  values for the wells that make up the set.

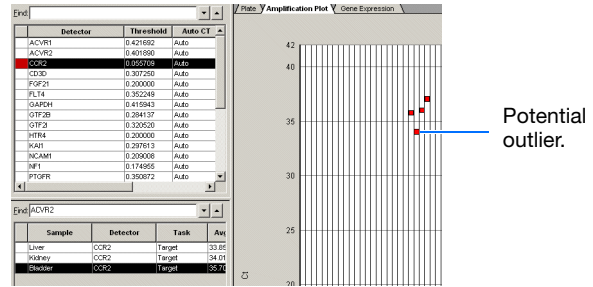
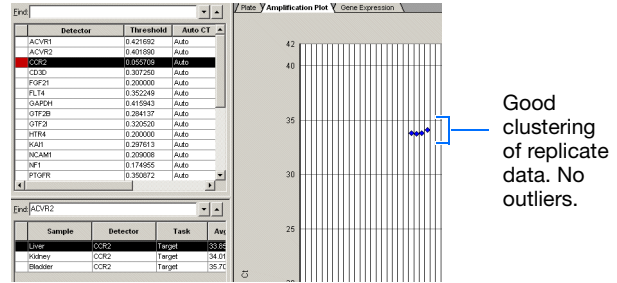

Notes

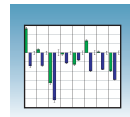

6. Do one of the following:
  - If outliers are present, select the **Well Information** tab, find the outlying sample, and select the **Omit** check box for the sample.
  - If outliers are not present, go to step 7.
7. Repeat steps 5 and 6 to screen the remaining replicate groups.
8. Select **Analysis > Analyze** (▶) to reanalyze the run without the outlying data.
9. Repeat steps 3 to 8 for other detectors you want to screen.

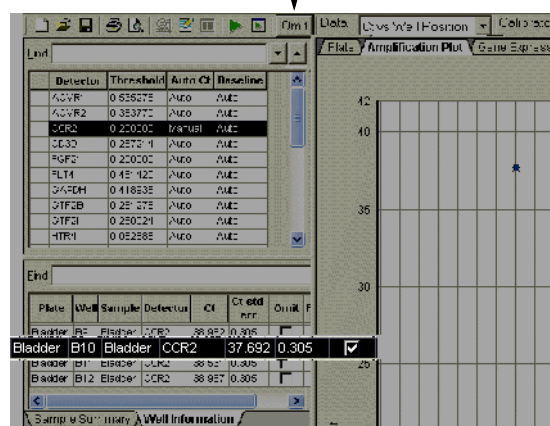
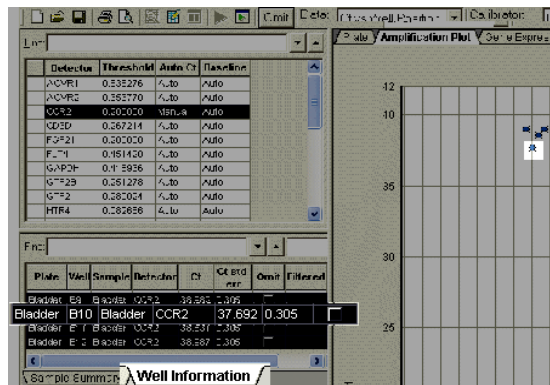

Select Omit.

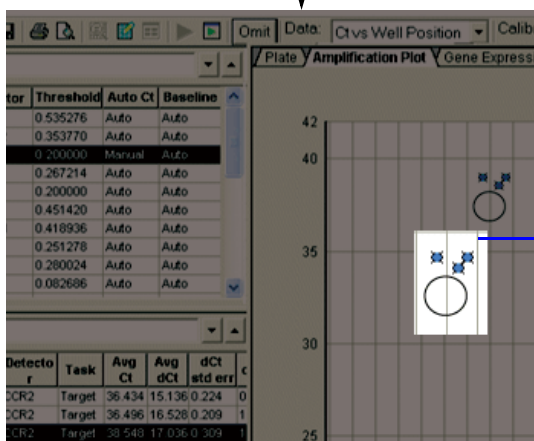

This is an enlarged version showing that the outlier is removed during analysis.

Notes

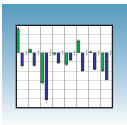

## Exporting RQ Study Data

You can export numeric data from RQ studies into text files, which can then be imported into spreadsheet applications such as Excel.

1. Select **File > Export > Results**, then select the data type to export:
  - **Sample Summary** (\*.csv)
  - **Well Information** (\*.csv)
  - **Both** (\*.csv)

Refer to the Online Help for information about the export file types.

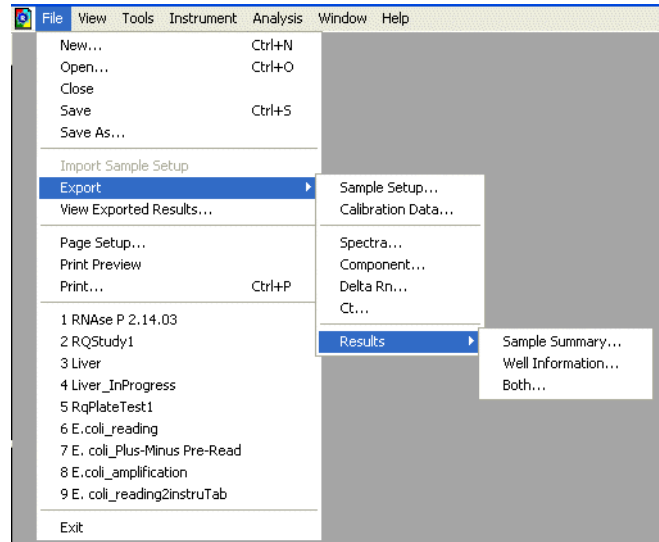

2. Enter a file name for the export file.

**Note:** The name of the dialog box depends on the type of data you want to export.

3. Click **Save**.

Notes \_\_\_\_\_



# Creating Detectors

A

Before you can use a plate document to run a plate, you need to create and apply detectors for all samples on the plate. A detector is a virtual representation of a gene- or allele-specific nucleic acid probe reagent used for analyses performed on instruments.

To create a detector:

1. Select **Tools > Detector Manager**.

**Note:** A plate document (any type) must be open before you can access the Tools menu.

2. Select **File > New**.

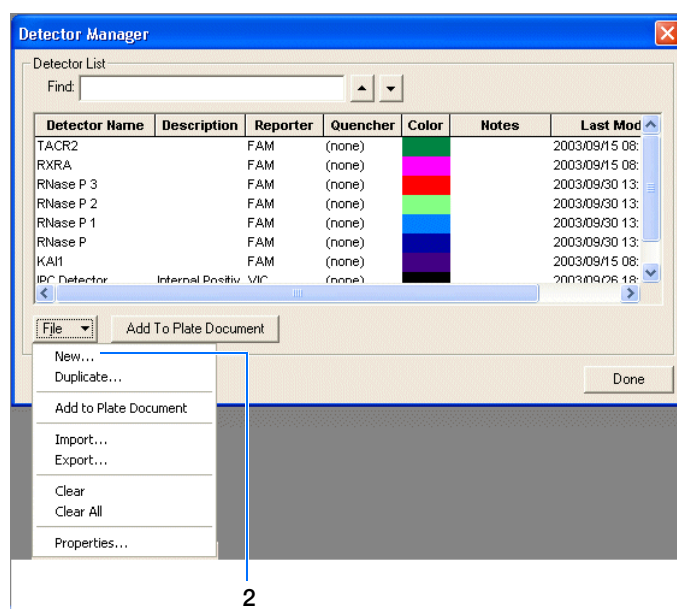

3. In the New Detector dialog box, enter a name for the detector.

**IMPORTANT!** The name of the detector must be unique and should reflect the target locus of the assay (such as GAPDH or RNase P). Do not use the same name for multiple detectors.

4. Optionally, click the **Description** field, then enter a brief description of the detector.

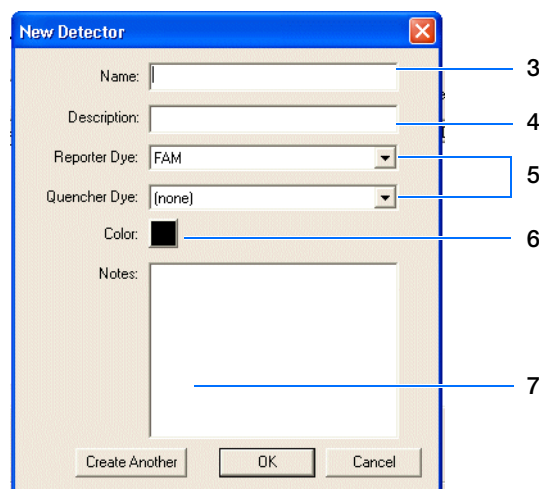

Notes

5. In the Reporter Dye and Quencher Dye drop-down lists, select the appropriate dyes for the detector.

---

**Note:** The dyes that appear on the Reporter and Quencher Dye lists are those that have been previously entered using the Dye Manager. If the dye that you want to use does not appear in a list, use the Dye Manager to add the dye and then return to this step in this procedure. Refer to the Online Help for more information.

---



---

**Note:** Select TAMRA as the quencher for TaqMan<sup>®</sup> probes and None for TaqMan MGB probes.

---

6. Click the **Color** box and select a color to represent the detector using the Color dialog box.
7. Optionally, click the **Notes** field, then enter any additional comments for the detector.
8. Click **Create Another** if you want to create another detector.
9. Click **OK** to save the detector and return to the Detector Manager.
10. Repeat [steps 2 through 9](#) for the remaining detectors.
11. In the Detector Manager, click **Done** when you finish adding detectors.

---

**Note:** TaqMan<sup>®</sup> Genotyping Assays are shipped with an assay information file (AIF). This text-based file contains information about the assays that you ordered, including the Applied Biosystems Assay ID number, well-location of each assay, primer concentration, and primer sequence. The file also indicates the reporter dyes and quenchers (if applicable) that are used for each assay. When creating detectors, you use the reporter dye and quencher information (and optionally, the gene name or symbol for the sample name). You can view the contents of AIFs in a spreadsheet program, such as Microsoft Excel.

---

### Sample Experiment

In the example RQ experiment, a detector is created for each target gene and the endogenous control. 24 detectors are created: 23 for the target genes and 1 for the endogenous control, GAPDH.

For example, the detector for the ACVR1 gene is named ACVR1 and assigned a yellow color. Because all TaqMan<sup>®</sup> Gene Expression Assays have probes that are labeled with FAM<sup>™</sup> dye, FAM was selected for the reporter dye. Additionally, TaqMan Custom Gene Expression Assays use TaqMan MGB probes, which use nonfluorescent quenchers. "None" is selected for the quencher dye.

### Notes

---



---

## Example RQ Experiment

**Overview** To better illustrate how to design, perform, and analyze RQ experiments, this section guides you through an example experiment. The example experiment represents a typical RQ experiment setup that you can use as a quick-start procedure to familiarize yourself with the RQ workflow. Detailed steps in the RQ workflow are described in the subsequent chapters of this guide. Also in the subsequent chapters are Example Experiment boxes that provide details for some of the related steps in the example experiment.

**Description** The objective of the example RQ experiment is to compare the levels of expression of 23 genes in the liver, kidney, and bladder tissue of an individual.

The experiment is designed for singleplex PCR: Samples and endogenous controls were amplified in separate wells. Glyceraldehyde-3-phosphate dehydrogenase (GAPDH) serves as the endogenous control. Four replicates of each sample and endogenous control are amplified. (In this experiment, an entire 96-well-plate is devoted to each tissue because the four replicates of each of the 23 genes plus the endogenous control require all 96 wells.)

Primer/probe sets are selected from the Applied Biosystems TaqMan<sup>®</sup> Gene Expression Assays product line.

Reactions are set up for two-step RT-PCR, where the High Capacity cDNA Archive Kit and the TaqMan<sup>®</sup> Universal PCR Master Mix are used for reverse transcription and PCR, respectively.

Data are generated by running three RQ plates, one for each tissue.

All three plates are analyzed in an RQ study, with the liver samples serving as the calibrator.

B

Notes \_\_\_\_\_

\_\_\_\_\_

\_\_\_\_\_

### Example RQ Experiment Procedure

1. Design the experiment, as explained in [Chapter 2](#) on [page 7](#).
  - a. Designate the targets, endogenous control, and replicates.
  - b. Order the reagents for TaqMan<sup>®</sup> probe-based chemistry.
  - c. Order the appropriate TaqMan<sup>®</sup> Gene Expression Assays products, which provide pre-designed primers and probes for the 23 genes.
2. Isolate total RNA from liver, kidney, and bladder tissue, as explained in [Chapter 3](#) on [page 18](#).
3. Generate cDNA from total RNA using the High Capacity cDNA Archive Kit.
  - a. Prepare the reverse transcription (RT) master mix as indicated in the table to the right.

Additional guidelines are provided in the *High Capacity cDNA Archive Kit Protocol*.

RT Master Mix - Standard Plate		
Component	μL/Reaction	μL/21 reactions <sup>‡</sup>
10X Reverse Transcription Buffer	10	210
25X dNTPs	4	84
10X random primers	10	210
MultiScribe™ Reverse Transcriptase, 50 U/μL	5	105
Nuclease-free water	21	441
Total	50	1050

<sup>‡</sup> Each RT reaction is 100 μL (see [step 3b](#)). If you need 5 μL cDNA for each of 104 PCR reactions per tissue (see [step 4](#)), you need 6 RT reactions per tissue. Extra volume (enough for one additional RT reaction per tissue) is included to account for pipetting losses, as well as extra cDNA for archiving.



**WARNING CHEMICAL HAZARD.** 10 × RT Buffer may cause eye, skin, and respiratory tract irritation. Read the MSDS, and follow the handling instructions. Wear appropriate protective eyewear, clothing, and gloves.

Notes \_\_\_\_\_

- b. Prepare the cDNA archive plate by pipetting into each well of the plate:

- 50  $\mu\text{L}$  RT master mix
- 30  $\mu\text{L}$  nuclease-free water
- 20  $\mu\text{L}$  RNA sample

Make sure the total amount of RNA is 10 to 100 ng for each 100- $\mu\text{L}$  reaction.

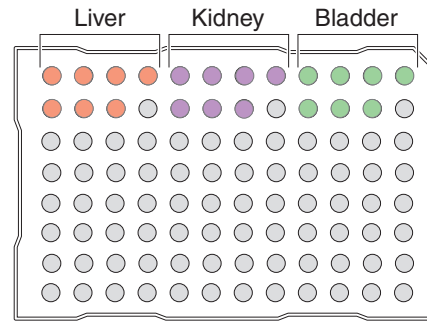

- c. Program the thermal cycler using the indicated parameter values for the RT step of the two-step RT-PCR method.

**Note:** You have the option to use one-step RT-PCR, as explained in “[Selecting One- or Two-Step RT-PCR](#)” on page 12.

Step Type	Time	Temperature
HOLD	10 min	25 °C
HOLD	120 min	37 °C

- d. Store the cDNA at  $-20\text{ }^{\circ}\text{C}$  until use.

4. Prepare the PCR master mix as indicated in the table to the right.

See [Chapter 4](#) on [page 22](#) for more information.

**Note:** The concentrations of TaqMan<sup>®</sup> Gene Expression Assays and TaqMan<sup>®</sup> Custom Gene Expression Assays are specified in the product insert. The concentrations of primers and probes designed with Primer Express software follow the universal assay conditions described in [Chapter 4](#).



**CAUTION CHEMICAL HAZARD.** TaqMan<sup>®</sup> Universal PCR Master Mix (2 $\times$ ) No AmpErase<sup>®</sup> UNG may cause eye and skin irritation. Exposure may cause discomfort if swallowed or inhaled. Read the MSDS, and follow the handling instructions. Wear appropriate protective eyewear, clothing, and gloves.

PCR Master Mix - Standard			
Reaction Component	$\mu\text{L}/$ Sample	$\mu\text{L}/$ 5 Reactions <sup>§</sup>	Final Concentration
TaqMan Universal PCR Master Mix (2 $\times$ )	25.0	125.0	1 $\times$
20 $\times$ TaqMan <sup>®</sup> Gene Expression Assay Mix <sup>‡</sup>	2.5	12.5	1 $\times$
cDNA sample	5.0	25.0	10 to 100 ng
Nuclease-free water	17.5	87.5	—
Total	50.0	250	—

<sup>‡</sup> Contains forward and reverse primers and labeled probe.

<sup>§</sup> 24 master mixes are prepared, one for each of 23 genes plus the endogenous control. Volume for five reactions (4 replicates plus extra) to account for pipetting losses.

Notes

**CAUTION CHEMICAL HAZARD.**  
**TaqMan Universal PCR Master Mix (2X) No AmpErase UNG** may cause eye and skin irritation. Exposure may cause discomfort if swallowed or inhaled. Read the MSDS, and follow the handling instructions. Wear appropriate protective eyewear, clothing, and gloves.

PCR Master Mix - Fast			
Reaction Component	μL/ Sample	μL/ 5 Reactions <sup>‡</sup>	Final Concentration
TaqMan Fast Universal PCR Master Mix (2X)	10.0	50.0	1X
20X TaqMan <sup>®</sup> Gene Expression Assay Mix	1.0	5.0	1X
cDNA sample and Nuclease-free water	9 μL	45 μL	10 to 100 ng —
Total	20.0	100	—

<sup>‡</sup> 24 master mixes are prepared, one for each of 23 genes plus the endogenous control. Volume for five reactions (4 replicates plus extra) to account for pipetting losses.

5. Prepare the reaction plates.
  - a. Label the reaction plates, ensuring that you include an endogenous control on each plate.
  - b. Pipette 50 μL (20 μL for the Fast system) of the appropriate PCR master mix (containing cDNA) into each well of the plate.
  - c. Keep the reaction plates on ice until you are ready to load them into the 7300/7500/7500 Fast system.

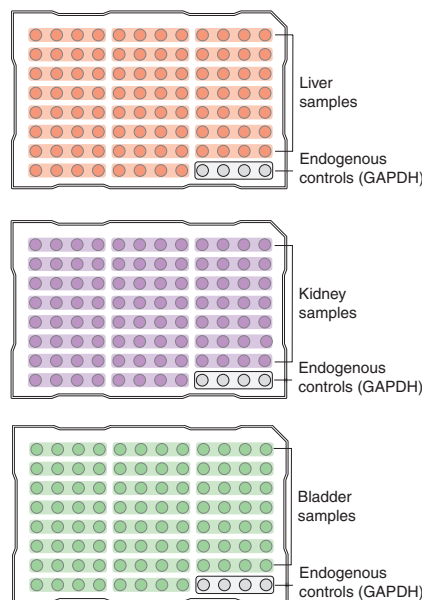

Fast system plates are notched in the A1 position on the top left and have a recommended 30 uL volume capacity.

Notes \_\_\_\_\_

6. Create an RQ Plate document as described in “Creating a Relative Quantification (RQ) Plate Document” on page 25.

**IMPORTANT!** All plates added to a study must have identical thermal cycling parameters—the same number of steps, cycles, sample volume, emulation mode. The SDS Software 1.3.1 rejects a plate if it detects any differences. (The first plate added to the study serves as the reference plate against which other plates are compared.)

- a. Select **File > New**.
- b. Select **Relative Quantification (ddCt) Plate** in the Assay drop-down list, then click **Next >**.

**IMPORTANT!** You cannot use AQ Plate documents for RQ assays and vice versa. The information stored in AQ and RQ Plate documents is not interchangeable.

- You cannot import an AQ plate into an RQ study.
- You cannot analyze your relative expression data directly in an RQ plate setup.
- You cannot run a standard curve or a dissociation curve in an RQ plate setup.
- You can only analyze relative expression data in an RQ study setup.

- c. Add detectors to the plate document, then click **Next >**.
- d. Specify the detectors and tasks for each well, then click **Finish**.

You cannot add RQ plates to RQ studies unless you have specified sample names, as indicated in the message shown to the right. Click **OK**.

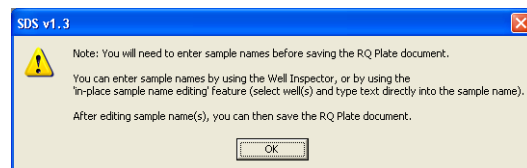
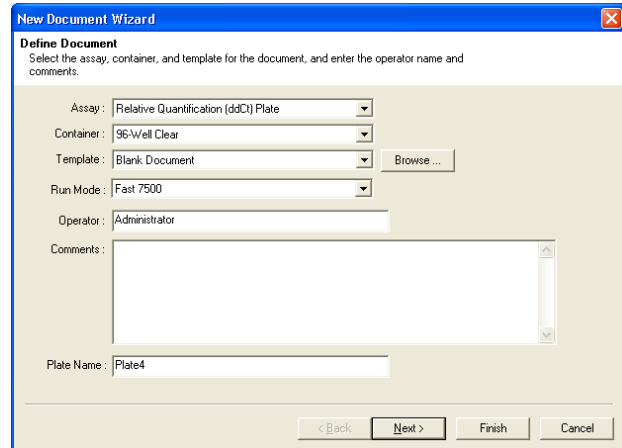

Notes \_\_\_\_\_

\_\_\_\_\_

\_\_\_\_\_

The SDS Software 1.3.1 displays the Well Inspector.

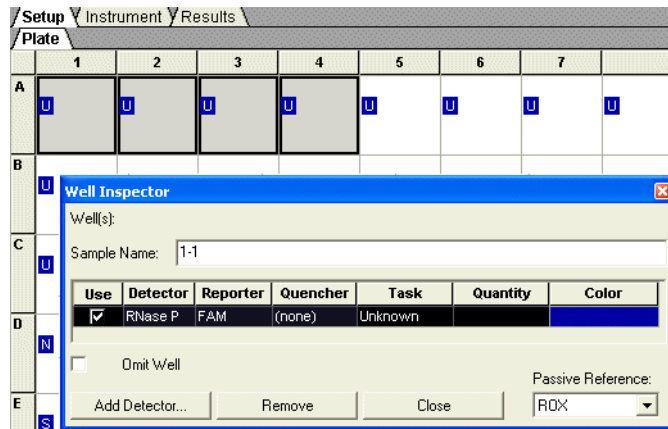

7. Enter the sample names in the Well Inspector (View > Well Inspector).

**IMPORTANT!** If your experiment does not use all the wells on a plate, do not omit the wells from use at this point. You can omit unused wells after the run is completed. For more information about omitting wells, refer to the Online Help.

The figure on the right shows a completed plate set up.



Notes \_\_\_\_\_



8. Start the RQ run.
  - a. Select the **Instrument** tab. By default, the Fast PCR conditions for the PCR step of the two-step RT-PCR method are displayed for the 7500 Fast instrument, whereas the standard PCR conditions are displayed for the 7300 and 7500 standard instruments (not shown).
  - b. Select **File > Save As**, enter a name for the RQ Plate document, then click **Save**.
  - c. Load the plate into the instrument.
  - d. Click **Start**.

After the run, a message indicates if the run is successful or if errors were encountered.

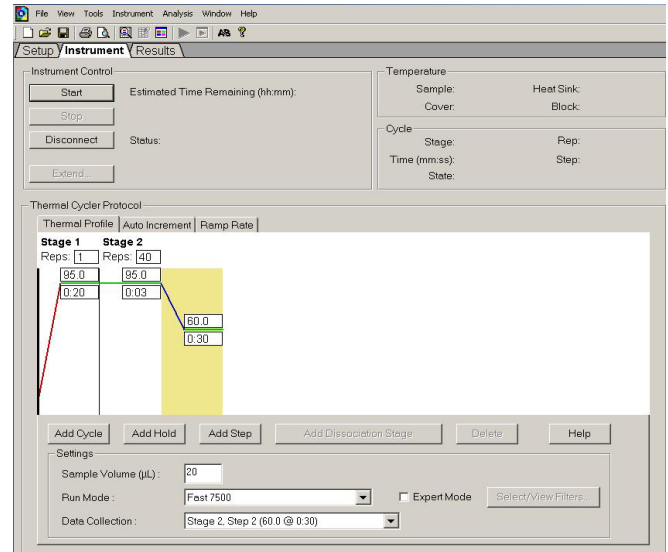

9. Create an RQ Study document as described in “Creating an RQ Study Document” on page 60.
  - a. Select **File > New**.
  - b. Select **Relative Quantification (ddCt) Study** in the Assay drop-down list, then click **Next >**.

**IMPORTANT!** RQ Study is an optional add-on for the 7300 instrument; it is built-in for the 7500 instrument and the 7500 Fast instrument.

- c. Click **Add Plates** to add plates to the study, then click **Open**.

**Note:** You can add up to 10 RQ plates to an RQ study.

- d. Click **Finish**.

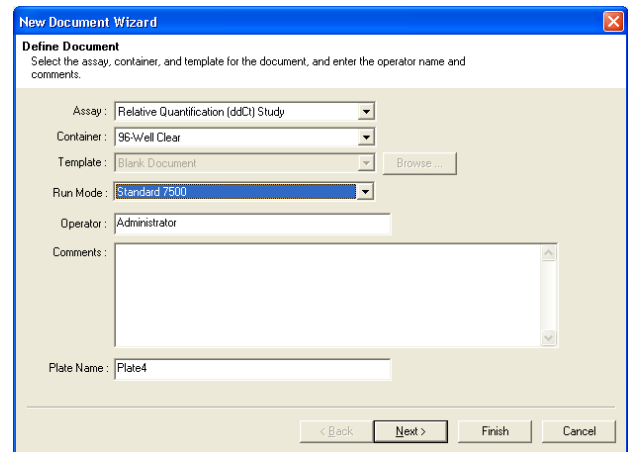

Notes \_\_\_\_\_

10. Analyze the RQ data, as explained in Chapter 6 on page 59.

- a. Configure analysis settings (  ), using the Auto Ct option and analyze the data.

**Note:** See “Configuring Analysis Settings” on page 63 for details.

If you know the optimal baseline and threshold settings for your experiment, you can use the Manual Ct and Manual Baseline options.

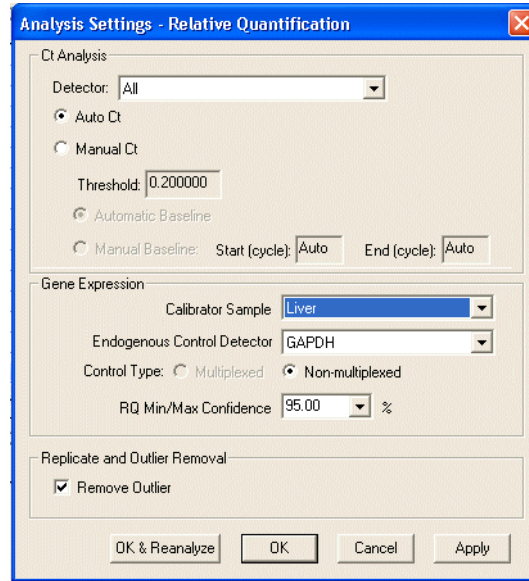

- b. If necessary, manually adjust the baseline and threshold.

**Note:** See “Adjusting the Baseline and Threshold” on page 65.

- c. Click , or select **Analysis > Analyze** to reanalyze the data.

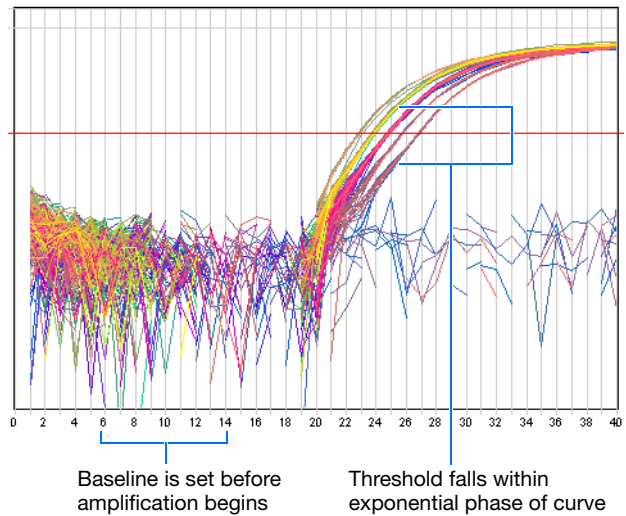

- d. View analysis results by clicking a tab in the RQ Results pane.
- e. If desired, save the RQ Study document.

**Conclusion**

As shown in the figure on the right where liver is used as the calibrator, expression levels of CCR2 are greater in the liver than in the kidney or bladder tissues of this individual.

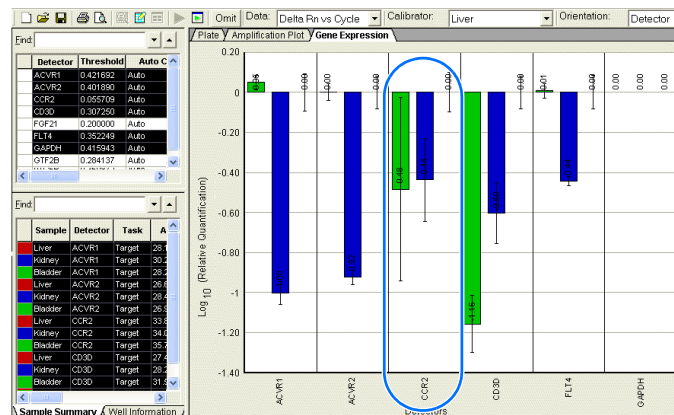

**Notes**

## References

Kwok, S. and Higuchi, R. 1989. Avoiding false positives with PCR. *Nature* 339:237–238.

Mullis, K.B. and Faloona, F.A. 1987. Specific synthesis of DNA *in vitro* via a polymerase-catalyzed chain reaction. *Methods Enzymol.* 155:335–350.

Livak, K.J., and Schmittgen, T.D. 2001. Analysis of Relative Gene Expression Data Using Real-Time Quantitative PCR and the  $2^{-\Delta\Delta CT}$  Method. *Methods* 25:402–408.

Saiki, R.K., Scharf, S., Faloona, F., *et al.* 1985. Enzymatic amplification of  $\beta$ -globin genomic sequences and restriction site analysis for diagnosis of sickle cell anemia. *Science* 230:1350–1354.



## Numerics

- 3D bars 72
- 5'-nuclease assay 11
- 9600 Emulation Mode 32

## A

- AIF. *See* assay information files
- AmpErase UNG 12
- amplification curve 65
- amplification plots
  - Amplification Plot view for RQ plates 35, 54
  - types of amplification plots for RQ studies 70
- appearance of graphs 33, 52, 71, 72
- Applied Biosystems
  - contacting x
  - customer feedback on documentation ix
  - Information Development department ix
  - Technical Support x
- assay information files 80
- assumptions for using this guide vii
- autoscaling options 33, 52, 71, 72

## B

- background in amplification curve 65
- bar width 72
- baseline
  - adjusting 65
  - definition 4
  - examples 66
- bold text, when to use vii

## C

- calibrating the 7300/7500 instrument 22
- calibrating the 7500 Fast instrument 38
- calibrator
  - definition 9
  - selecting in RQ studies 63
- CAUTION, description vii
- cDNA
  - generating 19
  - storing 20
  - See also* reverse transcription

- Chemistries 11
- comparative method of calculation 3, 60
- Component view 35, 53
- concentration of RNA 18
- confidence levels 64
- conventions
  - bold text vii
  - for describing menu commands vii
  - IMPORTANT! vii
  - in this guide vii
  - italic text vii
  - Notes vii
  - user attention words vii
- Ct. *See* threshold cycle
- curves
  - amplification 65
  - standard 2
- customer feedback, on Applied Biosystems
  - documents ix

## D

- data
  - analyzing 33, 52, 70
  - exporting 36, 55, 78
  - generating PCR data from RQ plates 32, 50
  - importing 26, 43
  - omitting from a study 75
- delta Rn 4
- Delta Rn vs.Cycle view 71
- designing RQ experiments
  - determining reagent configuration 11
  - PCR method 8
  - primers and probes 14
  - selecting the chemistry 11
- Detector Manager dialog box 79
- detector tasks, definition 25, 43
- detectors
  - adding to RQ plates 27, 45
  - creating 79
  - definition 79
  - selecting for RQ studies 63
- deviation, standard 67
- display options 33, 52, 71, 72
- documentation, related ix

## documents

- exporting 36, 55, 78
- RQ Plate 25, 43
- RQ Study 60
- templates 26, 43

## dyes

- FAM 14, 80
- reporter 4
- ROX 28, 35, 46, 54
- SYBR Green I 11, 13
- TAMRA 35, 54, 80

**E**

- emulation mode, 9600 32
- endogenous controls
  - associating with detectors 25, 43
  - definition 9
  - for RQ plates 25, 43
  - selecting for RQ studies 63
- endpoint PCR 2
- equipment 5
- example RQ experiment 5
  - components 10
  - creating detectors 80
  - description 81
  - overview 5
  - PCR master mix 24, 42
  - PCR method 8
  - reverse transcription 20
  - RQ Plate document, example 29, 47
  - RQ Study document, example 70
- Expert Mode 48, 50
- exponential phase of amplification curve 65
- exporting data
  - RQ plates 36, 55
  - RQ studies 78

**F**

- FAM dye 14, 80
- Fast system
  - creating an RQ plate document 43
  - example experiment 42
  - generating data from RQ plates 37
  - requirements 38
  - thermal cycling conditions 49
- Fast vs. standard plates 40

**G**

- Gene Expression plots 72
- graph settings 33, 52, 71, 72
- guidelines
  - preparing RNA 18

**H**

- High Capacity cDNA Archive kit 19

**I**

- importing plate setup information 26, 43
- Information Development department, contacting ix
- Instrument tab 32, 50
- italic text, when to use vii

**L**

- line width 33, 52, 71, 72
- linear phase of amplification curve 65

**M**

- master mix, PCR 22, 38
- materials 5
- menu commands, conventions for describing vii
- mode, emulation 32
- MSDSs, obtaining x
- multiplex PCR 8

**N**

- New Detector dialog box 79
- normalized reporter 4

**O**

- options, display 33, 52, 71, 72
- options, graph 33, 52, 71, 72
- outliers 75

**P**

- passive reference 4, 28, 46
- PCR
  - end-point 2
  - master mix, preparing 22, 38
  - multiplex 8
  - real-time 2
  - selecting a method 8
  - singleplex 8
  - starting an RQ plate run 32, 51
- phases of amplification curve 65
- Plate view 34, 53
- plate, RQ. *See* RQ plates
- plateau phase of amplification curve 65
- plot appearance 33, 52, 71, 72
- Primer Express Software 14
- primers 14

probes 14, 80

## R

reagent configurations 12

Real-Time PCR assays 2

reference sample. *See* calibrator

reference, passive 4, 28, 46

relative quantification

comparative method of calculation 3

definition 2

experiments. *See also* RQ experiments 3

real-time PCR 2

references 2

RQ plates 3

RQ studies 3

replicates 9

reporter dye 4

Results tab 33, 52

results, RQ Study analysis 70

reverse transcription

guidelines for preparing RNA 18

High Capacity cDNA Archive kit 19

thermal cycling parameters 19

Rn vs. Cycle view 71

Rn. *See* normalized reporter

RNA

guidelines for preparing 18

isolation 18

starting concentration 18

ROX dye 28, 35, 46, 54

RQ Detector grid 64

RQ experiments

chemistries 11

components 9

probes and primers 14

reagent configuration 11

requirements 9

workflow 3

RQ Main Study view 62

RQ plates

adding to RQ studies 61

Amplification Plot view 35, 54

analyzing 33, 52

Component view 35, 53

data types 36, 55

definition 3

detectors, creating 79

exporting data 36, 55

Plate view 34, 53

reanalyzing data 35, 54

results 33, 52

RQ Plate documents 25, 43

Spectra view 34, 53

starting a run 32, 51

RQ Results panel 70

RQ Sample grid 70

RQ studies

adding RQ plates 61

Amplification Plots 70

confidence level 64

control type 64

data types 78

definition 3

exporting data 78

Gene Expression plots 72

omitting samples from 75

orientation 72

reanalyzing data 74

results 70

RQ Study documents 60

RT-PCR

one-step 12, 31

two-step 12, 30, 49

## S

settings, graph 33, 52, 71, 72

Setup tab 28, 46

singleplex PCR 8

Spectra view 34, 53

standard curves 2

standard deviation, effect of threshold on 67

standard error 67

standard vs. Fast plates 23

starting an RQ plate run 32, 51

study, RQ. *See* RQ studies

SYBR Green I dye chemistry 11

## T

TAMRA dye 35, 54, 80

TaqMan Assays 14

TaqMan Custom Gene Expression Assays 14

TaqMan MGB probes 15, 80

TaqMan reagent chemistry 11

TaqMan Universal PCR Master Mix 22

TaqMan® Gene Expression Assays 14

target

associating with detectors 25, 43

definition 9

tasks. *See* detector tasks

Technical Support, contacting x

template documents 26, 43

text conventions vii

thermal cycling conditions

default for PCR 30, 49

## Index

- one-step RT-PCR 31
- specifying 32, 50
- two-step RT-PCR 30, 49
- thermal cycling parameters
  - for plates added to a study 61, 85
  - RT using High Capacity cDNA Archive kit 19
- threshold
  - adjusting 65
  - definition 4
  - examples 67
- threshold cycle
  - definition 4
  - setting for RQ studies 63
- training, information on x

## U

- uracil-N-glycosylase 12
- user attention words, described vii

## W

- WARNING, description vii
- Well Information tab 70
- wells, replicate 9
- width, bars 72
- width, lines 33, 52, 71, 72
- workflow, RQ experiment overview 3

## X

- x-axis 33, 52, 71, 72

## Y

- y-axis 33, 52, 71, 72





**Worldwide Sales and Support**

Applied Biosystems vast distribution and service network, composed of highly trained support and applications personnel, reaches 150 countries on six continents. For sales office locations and technical support, please call our local office or refer to our Web site at [www.appliedbiosystems.com](http://www.appliedbiosystems.com).

Applied Biosystems is committed to providing the world's leading technology and information for life scientists.

**Headquarters**

850 Lincoln Centre Drive  
Foster City, CA 94404 USA  
Phone: +1 650.638.5800  
Toll Free (In North America): +1 800.345.5224  
Fax: +1 650.638.5884

06/2010